

IN CONSTANT PURSUIT OF EXCELLENCE

An **RNG** Company

**Kraus Group Inc.**

# MICON 500C™

ELECTRONIC SEQUENCING COMPUTER  
INSTALLATION MANUAL:

NORTH AMERICAN AND EUROPEAN

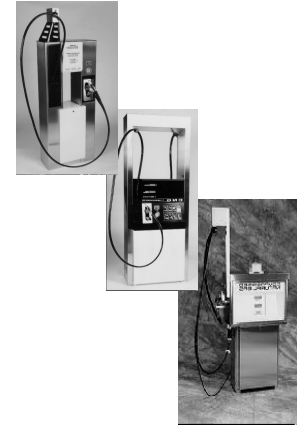

**FOR COMPRESSED  
NATURAL GAS (CNG)  
FLOW APPLICATIONS.**

**THIS IS YOUR GUIDE TO  
INSTALLING THE MICON  
500C™ ELECTRONIC  
SEQUENCING  
COMPUTER, DESIGNED  
TO SIMULATE  
MECHANICAL CNG  
REGISTERS.**

**TOTAL SALE**  
\$ **E 000 I**

**ACHAT TOTAL**

**E 000 I**

**LITRES**

**E3.00 =**

**PRICE PER LITRE INCLUDES TAXES  
PRIX DU LITRE TAXE COMPRISE**



# TABLE OF CONTENTS

1.0	SERVICE AND PRODUCT SUPPORT - CANADA .....	1
2.0	PRE-INSTALLATION CHECK.....	2
3.0	PHYSICAL MOUNTING CONSIDERATIONS.....	5
3.1	HANDLE SWITCH COUPLING.....	6
3.2	HANDLE SHAFT ACTUATION.....	8
4.0	CUSTOMER HARNESS LEAD ELECTRICAL CONNECTIONS.....	10
4.1	IMPORTANT WARNINGS.....	10
4.2	WIRING DETAIL – NORTH AMERICAN.....	11
	<b>4.2.1 FIGURE 11 - WIRING DIAGRAM – NORTH AMERICAN.....</b>	<b>12</b>
4.3	WIRING DETAIL - EUROPEAN .....	13
	<b>4.3.1 FIGURE 12 - WIRING DIAGRAM – EUROPEAN.....</b>	<b>14</b>
4.4	COMMUNICATION INTERFACE CONNECTIONS.....	15
5.0	POST INSTALLATION CHECK.....	16
6.0	MICON 500C OPERATION.....	17
6.1	CONSOLE ACCESSING FOR PRICE CHANGING: MCIU.....	17
6.2	MICON 500C COMMUNICATOR OPERATION.....	18
6.2.1	READING TOTALIZERS ON A SINGLE TIER DISPENSER.....	18
6.2.2	SETTING PRICES ON A SINGLE TIER DISPENSER.....	19
6.2.3	READING CURRENT PRODUCT FLOW RATE, TEMPERATURE AND PRESSURE.....	20
6.3	TWO TIER PRICE OPERATION.....	21
6.3.1	TWO TIER OPTION INSTALLATION.....	21
6.3.2	SETTING PRICES ON A TWO TIER DISPENSER.....	22
6.3.3	MAKING DISCOUNT PRICE SALES ON A TWO TIER DISPENSER.....	22
6.3.4	READING TOTALIZERS ON A TWO TIER DISPENSER.....	23
6.4	ELECTRONIC AUDIT TRAILS.....	24

TABLE OF CONTENTS (CONT'D)

7.0	MICON 500C SEQUENCING.....	25
7.1	DEFINITIONS – INFO-PAC SEQUENCING SETTINGS.....	26
7.1.1	MIN FLOW (minimum flow).....	26
7.1.2	MAX FLOW (maximum flow).....	27
7.1.3	IPTP FLOW 1 (increased pressure trip point – flow 1).....	27
7.1.4	IPTP FLOW 2 (increased pressure trip point – flow 2).....	27
7.1.5	FILL OPTION.....	27
7.1.5.1	FILL OPTION 1.....	28
7.1.5.2	FILL OPTION 2.....	29
8.0	PFS 3000 / 3600 PRESSURE-TEMPERATURE COMPENSATION SYSTEM.....	32
8.1	GENERAL DESCRIPTION.....	32
8.2	HARDWARE.....	33
8.2.1	HARDWARE INPUTS.....	33
8.3	SOFTWARE.....	34
8.4	END-OF-FILL DETERMINANTS.....	35
8.5	RESTART TIMEOUT AND NOISE BLANKING.....	35
8.6	EXCESS FLOW / EXCESS FILL.....	36
8.7	OPTIONAL PARAMETERS.....	37
8.8	FAILURE PROTECTIONS.....	38
8.9	SYSTEM REDUNDANCIES.....	39
8.10	ALARMS.....	39
9.0	MICON 500C FAULT CODES.....	40

TABLES

1.	ACCESSORY / OPTIONAL PARTS - KRAUS .....	5
2.	MICON 500C WIRING DETAIL (NORTH AMERICAN).....	11
3.	MICON 500C WIRING DETAIL (EUROPEAN).....	13
4.	COMMUNICATIONS INTERFACE CONNECTIONS FOR THE MICON 500CN (NORTH AMERICAN).....	15
5.	COMMUNICATIONS INTERFACE CONNECTIONS FOR THE MICON 500CE (EUROPEAN).....	15
6.	<b>M500</b> INFO-PAC PROGRAMMABLE FEATURES (FOR CNG); SOFTWARE VERSION 3.0 .....	25
7.	<b>M500C</b> INFO-PAC PROGRAMMABLE FEATURES (FOR CNG); SOFTWARE VERSION 3.0 .....	26

TABLE OF CONTENTS: TABLES (CONT'D)

8.	WIRE CONNECTIONS – FILL OPTION 1 .....	28
9.	WIRE CONNECTIONS – FILL OPTION 2 .....	29
10.	PFS 3000 / 3600 SYSTEM HARDWARE INPUTS .....	33
11.	ABSOLUTE PRESSURE .....	34
12.	ALARM SHUTDOWN TRIGGERS AND RESET ACTIONS .....	40
13.	MICON 500C FAULT CODES .....	41
14.	SUMMARY OF FAULT CLEARING ACTIONS .....	42

FIGURES

1.	BATTERY OFF ACTUATOR SHAFT POSITION.....	2
2.	COUPLER ASSEMBLY HANDLE OFF POSITION.....	2
3.	INFO-PAC AND CONFIGURATION EVENT COUNTERS ON THE MICON 500C.....	3
4.	RECEIVING DATA FROM MICON 500C.....	4
5.	“RECEIVED MICON” INFO-PAC DISPLAY.....	5
6.	STANDARD ACTUATOR SHAFT AND COUPLER ASSEMBLY POSITION.....	6
7.	INTRINSICALLY SAFE TWO PIN PLUG.....	7
8.	CUSTOMER LEAD EXIT.....	7
9.	ACTUATOR SHAFT AND COUPLER ASSEMBLY POSITION FOR CLOCKWISE ROTATION.....	8
10.	HANDLE SHAFT ACTUATION FOR CLOCKWISE ROTATION .....	9
11.	WIRING DIAGRAM – NORTH AMERICAN .....	12
12.	WIRING DIAGRAM – EUROPEAN.....	14
13.	PRICE SETTING USING THE MICON COMMUNICATOR.....	16
14.	DISPLAY DOLLAR AND VOLUME TOTALS.....	18
15.	PRICE SETTING USING THE MICON COMMUNICATOR.....	19
16.	READING TOTALIZERS.....	24
17.	FILL OPTION 1.....	29
18.	FILL OPTION 2.....	31
19.	FAULT CODE IN PRICE DISPLAY.....	40

## 1.0 SERVICE AND PRODUCT SUPPORT - CANADA

Should you experience any difficulties in system operation, customer assistance is available.

The procedure to receive such assistance is as follows:

### 1. Document the following information:

- system dysfunction
- corrective measures taken
- system model number
- system serial number
- purchase order information
- date of installation
- equipment location (i.e., city, address, etc.)

### 2. Call or Fax our Product Service line at:

**company service number:**

**1-204-988-1234**

**company fax number: 1-204-654-2881**

One of our qualified personnel will provide assistance in getting your system operational.

KRAUS GROUP INC. assumes no liability or responsibility whatsoever pertaining to the accuracy or currency of the information supplied in this manual. Installation of MICON 500C electronic pumpheads in every case is the sole responsibility of the installer performing the work. Kraus Group Inc. assumes no liability or responsibility whatsoever resulting from any type of installation, operation or configuration, whether performed properly, improperly or in any other way. The information supplied herein is a guide only.

MICON 500 is a registered trademark of Kraus Group Inc.

## 2.0 PRE-INSTALLATION CHECK

The MICON 500C is an electronic pumphead designed for use with compressed natural gas (CNG) dispensers.

After carefully unpacking the MICON 500C, inspect for shipping damage. Refer to the options label(s) on the MICON 500C shipping box(es) to ensure the MICON 500C is properly configured for the intended application. A preliminary electrical check should be performed as follows:

1. Observe position of the pump handle. The MICON 500C is normally shipped with the actuator shaft in the OFF position: flat (beveled) surface on the end of the shaft facing DOWN. Current drain will be negligible, however, if unit shipped with battery ON.

**FIGURE 1 – BATTERY OFF ACTUATOR SHAFT POSITION**

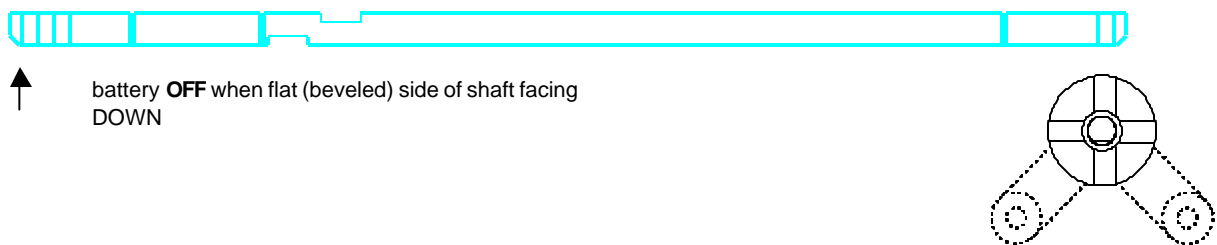

2. Battery is ON whenever flat (beveled) side of shaft is facing any direction except DOWN. Battery should be ON with flat (beveled) side of shaft facing UP when handle OFF. Prepare handle switch for a preliminary check by positioning shaft and coupler assembly in **handle OFF** position:
  - a) Pull cotter pin.
  - b) Rotate actuator shaft until the flat (beveled) side faces UP.
  - c) Rotate the coupler assembly until it snaps against the opposite stop pin.
  - d) Re-install cotter pin in a vertical position.

The handle OFF coupler assembly will appear as in Figure 2 below. Coupler assembly may rest against stop pin #1 or stop pin #2, as long as cotter pin is vertical and flat (beveled) side of shaft faces UP when handle OFF.

**FIGURE 2 – COUPLER ASSEMBLY HANDLE OFF POSITION**

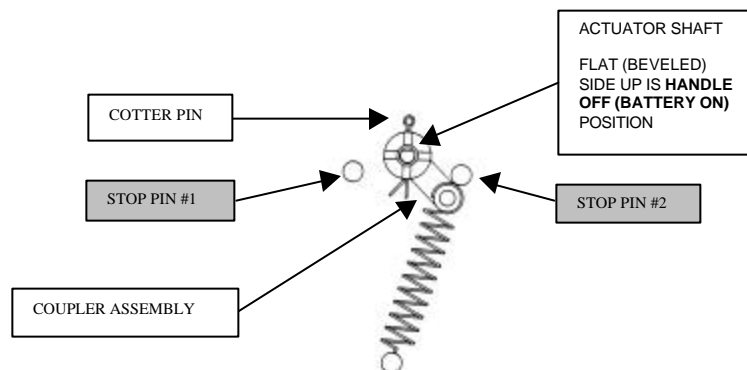

3. The MICON 500C digital display can be manually triggered to display configuration event counters data in the dollar and volume displays, followed by the software version number in the price display. To do this:
  - Flip the handle switch rapidly ON, then OFF. The display will show the configuration event counters in the dollar and volume displays, and the software version in the **price display**.
  - The event counter in the **dollar display** indicates the number of times settings have been changed in “MICON” mode (metrological configuration parameters) with the INFO-PAC.
  - The event counter in the **volume display** indicates the number of times the settings have changed in the “m500C” mode of the INFO-PAC.

**FIGURE 3 – INFO-PAC AND CONFIGURATION EVENT COUNTERS ON THE MICON 500C**

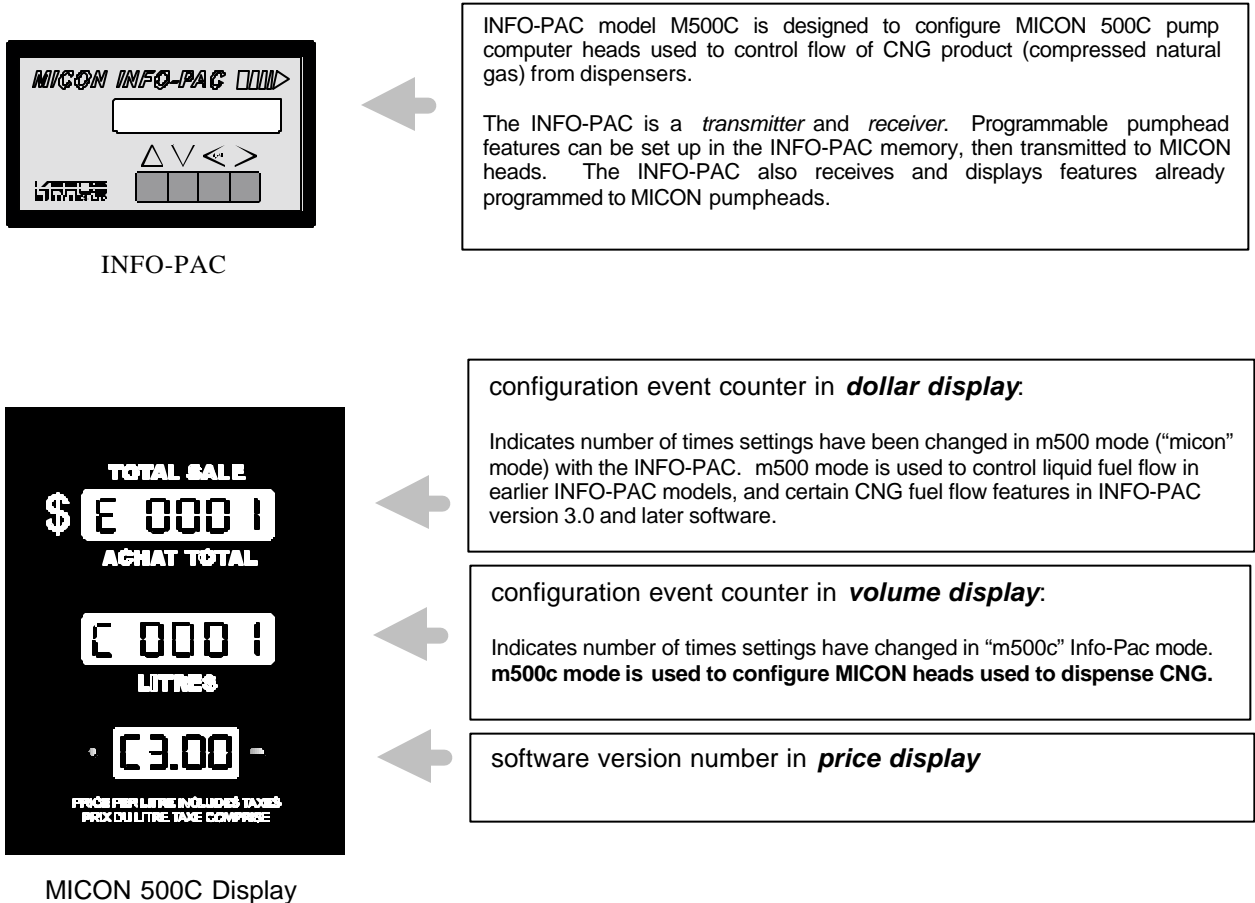



4. Figure 3 (preceding page) indicates both counters (dollar and volume) are set to 0001. To check the current configuration of your MICON 500C, use the INFO-PAC *receive* functions, described in the **INFO-PAC m500C Programming Manual**, and outlined in steps a) to d) below:

The **RX MICON** (m500) setting on the INFO-PAC is designed to receive MICON 500C settings from units which have already been programmed.

*To receive information from the MICON 500C:*

- a) Go to breaker box and turn power OFF. **Caution: Ensure breaker box does not feed power to equipment which should remain ON.**

**The MICON 500C display should be flashing.** If display is blank, unit is in *sleep (i.e., battery save)* mode. To correct this, turn handle ON and OFF. Display will start flashing.

- b) Turn INFO-PAC m500C ON by pressing left arrow key. Using up or down arrow key, scroll to INFO-PAC RX MICON option. Set **RX MICON on** by pressing left or right pointing arrow key.
- c) Take INFO-PAC and go to the front display of the MICON 500C electronic pumphead. Locate optical sensor (oval "hole") at right of price display on MICON 500C.

Aim INFO-PAC receiver / transmitter (located behind red tinted filter at centre edge of INFO-PAC at MICON 500C optical sensor.

**FIGURE 4 – RECEIVING DATA FROM MICON 500C**

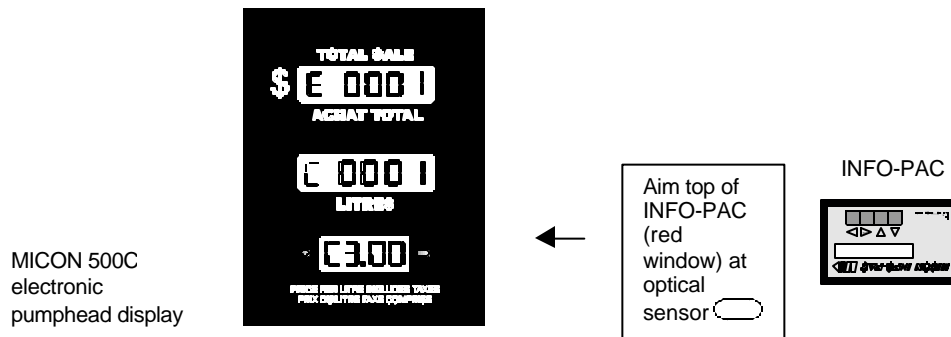

Red LED to left of MICON 500C price display flashes as INFO-PAC receives data from MICON 500C.

- d) When INFO-PAC has received a copy of the MICON 500C setup information correctly, INFO-PAC display will show "Received Micon". To view each setting, scroll with the up or down arrow key. (Default settings are summarized in Table 6 and 7, pages 25, 26.)

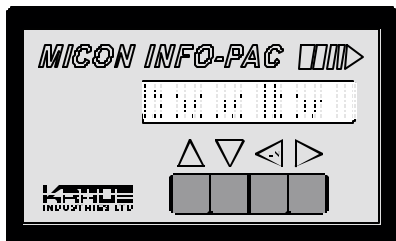

FIGURE 5 – "RECEIVED MICON" INFO-PAC DISPLAY

4. Enter a price. See section 6.2.2 – Setting Prices, page 19 for a description of the procedure. Price *reading* is also described in section 6.2.1 – Reading Totalizers, page 18.

Setting prices and reading totalizers on two tier dispensers is described on pages 22 and 23, sections 6.3.3 and 6.3.4.

For a detailed explanation of INFO-PAC operation, see INFO-PAC MICON 500C Programming Manual.

**If any faults are detected during this preliminary check, consult your factory or service representative.**

### 3.0 PHYSICAL MOUNTING CONSIDERATIONS

Kraus Group Inc. is presently offering accessory parts to facilitate the field installation of the MICON 500C into various dispensers. These accessory parts, listed in Table 1 below, must be ordered separately. Consult your service representative.

TABLE 1 – ACCESSORY / OPTIONAL PARTS - KRAUS

PART NO.	ACCESSORY / OPTIONAL PARTS - KRAUS
W392	2-TIER SWITCH HARNESS
W199	RESISTIVE TEMPERATURE PROBE
Y101	KEY SWITCH
PWP 320	PUSH BUTTON SWITCH (PRICING)
DS 18	HANDLE LINK UNIT
247KT00	MCIU CONTROL BOX
MC 200D	COMMUNICATOR (HAND HELD)

### 3.1 HANDLE SWITCH COUPLING

1. The handle switch coupling on the side of the MICON 500C must be connected to the dispenser handle. In most installations, the dispenser handle can be coupled directly to the MICON 500C. The MICON 500C handle switch can be turned to the **ON** position by rotating the actuator shaft 90 degrees in either a clockwise or counterclockwise direction. The direction of rotation is dependent upon the position of the dispenser handle in relation to the coupler.

**To verify correct placement of the actuator, the flat (beveled) side of the shaft should be in the battery ON position when the dispenser handle is OFF. This will be flat side UP (battery actually is ON in any position except flat side DOWN).**

**FIGURE 6 – STANDARD ACTUATOR SHAFT AND COUPLER ASSEMBLY POSITION**

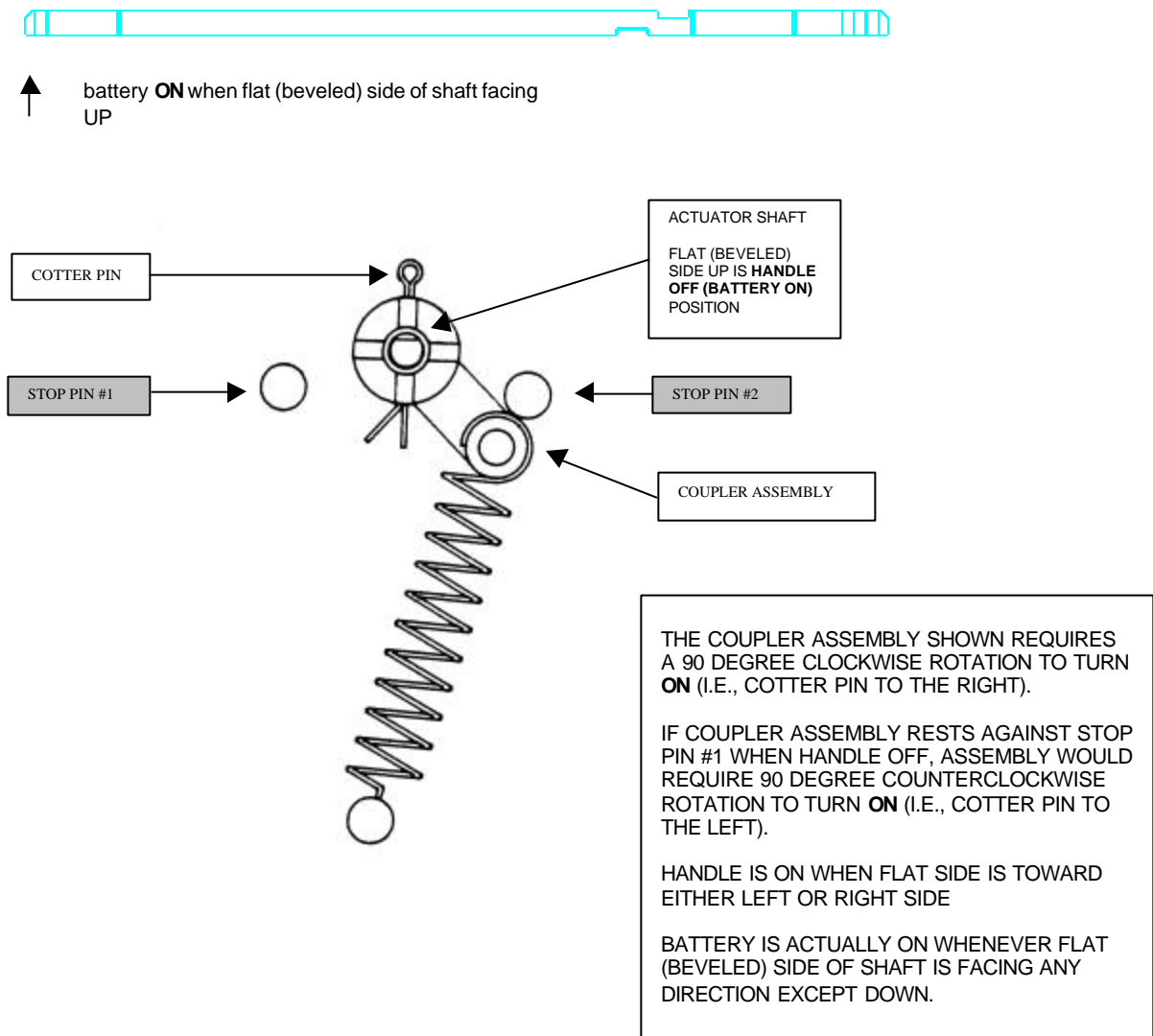

2. If desired, a normally open handle switch can be connected to the intrinsically safe 2 pin plug. In this case, the actuating shaft need not be connected and should be left in the **Handle OFF** position.

**FIGURE 7**

**INTRINSICALLY SAFE 2 PIN PLUG**

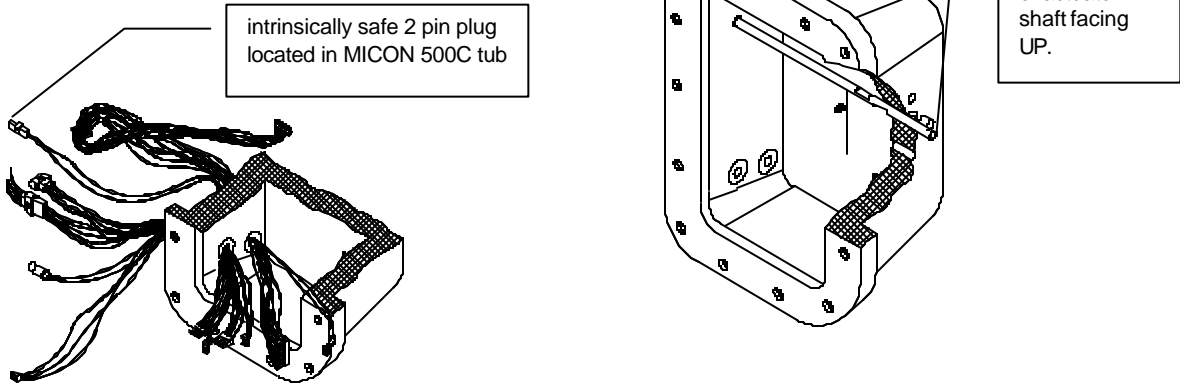

3. Customer lead exit, located on the top of the explosion-proof housing, must be connected to a suitable junction box with rigid conduit (North American only). A seal fitting must be installed between the MICON 500C and the junction box, and must be within 18" of the MICON 500C.

**FIGURE 8**

**CUSTOMER LEAD EXIT**

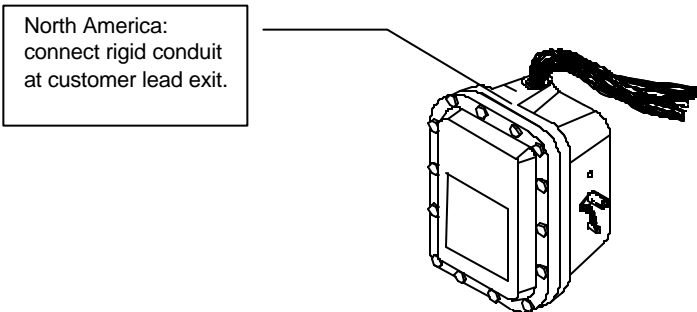

### 3.2 HANDLE SHAFT ACTUATION

As outlined in explanation accompanying Figure 6, page 6, the MICON 500C handle switch may be switched **ON** by rotating the actuator shaft 90 degrees in either direction. As shipped from the factory, a clockwise rotation of the coupler assembly (as viewed from the coupler side) is required to switch the pumphead ON.

If the installation requires a counterclockwise rotation



to turn the head **ON**, see Figure 9 below and complete the following steps:

- Turn the coupler assembly to the desired **handle OFF** position (i.e., against stop pin #1).
- Remove the cotter pin which secures the coupler assembly to the actuator shaft.
- Rotate the actuating shaft until the flat (beveled) surface on the end is facing upwards, and re-install the cotter pin in a vertical position.

**FIGURE 9**

**ACTUATOR SHAFT AND COUPLER ASSEMBLY POSITION FOR COUNTERCLOCKWISE ROTATION**

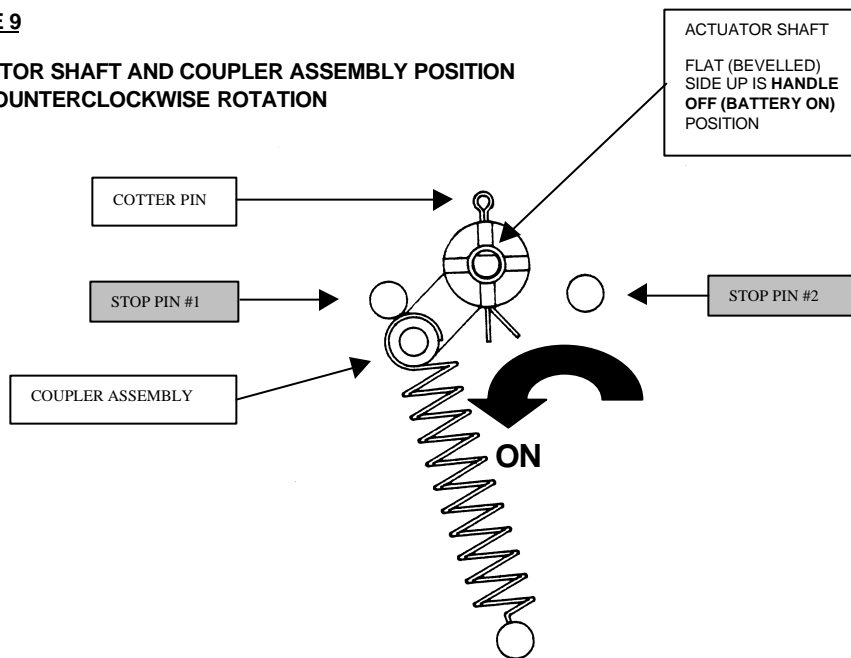

THE COUPLER ASSEMBLY SHOWN IS RESTING AGAINST STOP PIN #1 WHEN IN **HANDLE OFF (BATTERY ON)** POSITION, AND REQUIRES A 180 DEGREE CLOCKWISE ROTATION TO TURN **ON** (I.E., COTTER PIN TO THE LEFT).

FLAT (BEVELLED) END OF ACTUATOR SHAFT IS FACING UP WHEN HANDLE OFF AND SNAPS TO NEGATIVE **90 DEGREE ANGLE** WHEN **HANDLE ON AND BATTERY ON**.

**FIGURE 10**

**HANDLE SHAFT ACTUATION  
FOR CLOCKWISE ROTATION**

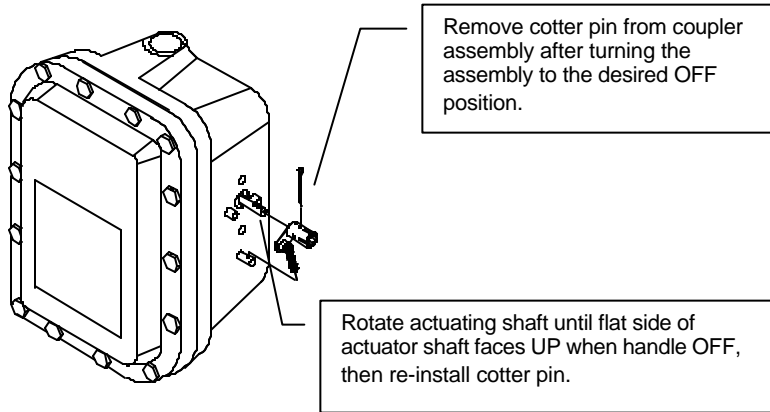

## 4.0 CUSTOMER HARNESS LEAD ELECTRICAL CONNECTIONS

### 4.1 IMPORTANT WARNINGS

#### **!!! IMPORTANT – PLEASE READ !!!**



**WARNING**

**All wiring must be installed in accordance with national and local electrical codes.**

**Substitution of components may impair intrinsic safety.**



**ATTENTION**

**When this unit is used in retail trade in Canada, Measurement Canada, an agency of Industry Canada, must be notified of the installation or servicing of this unit. This unit is subject to inspection upon installation and at such other times as the regulations may state.**



**CAUTION**

**When performing installation or maintenance work of any kind, including servicing MICON 500C electronic pumphead main boards or using the INFO-PAC to program pumpheads, it is the responsibility of the service person performing the work to ensure:**

- 1. All power to MICON pumphead(s) is turned OFF.**
- 2. All supply of gas to dispenser(s) being serviced is shut OFF.**

KRAUS GROUP INC. assumes no responsibility for personal injury or equipment damage caused by non-observance of safety warnings, or non-compliance with national or international legal regulatory requirements.

## 4.2 WIRING DETAIL - NORTH AMERICAN

<b>Table 2: MICON 500C Wiring Detail (North American) Reference: Drawing #5789-8, page 12</b>	
<b>Wire #</b>	<b>120 VAC Lines - (Wire #3a, #3b, #7, #8 are 14 AWG. All other wires are 18 AWG.)</b>
1 (BLK)	120 VAC head power hot line. If power is interrupted on this line, the head will go into standby and power-fail modes.
2 (WHT)	Neutral for head power and main board authorize/authorize request circuit.
3A & 3B (GRN)	Earth. These lines are connected internally to the casting and must be connected to the service ground.
7 (BLK)	120 VAC Sequencing Power
8 (ORN)	Sequencing Output #1
14 (BRN)	Authorize Input. Application of 120 VAC will “authorize” the MICON 500C to dispense product. When the handle switch is turned ON, the MICON 500C applies a 2.7 K $\Omega$ capacitive reactance between this line and wire #2 to serve as an authorize request load for Kraus Group Inc. Self-Serve equipment. External equipment may be used to provide an authorization signal to the Micon 500LN Electronic Register provided that both units are controlled through a common circuit breaker.
15 (GRY)	Authorize Output. When 120 VAC is applied to wire #14 and the handle switch is ON, 120 VAC will be present on this line. (3 Amp. maximum load)
21 (WHT/GRN)	Sequencing Output #2
22 (WHT/YEL)	Sequencing Output #3
23 (WHT/ORN)	Sequencing Output #4
24 (WHT/RED)	Sequencing Output #5
<b>Wire #</b>	<b>Low Voltage Lines</b>
4 (YEL)	Money Pulser Positive. This line is normally connected to the pulser power supply positive line (+30 volts maximum, DC only) and provides power to the money pulser line.
5 (RED)	Money Pulser Negative (output). The MICON 500C will source a maximum of 100 mA from the money pulser positive (#4) to this line to form a pulse once for each penny of product dispensed. (Used with KRAUS MONITOR and MICRO consoles.)
12 (YEL/RED)	LAG Pulser Input Positive. This line is connected through a 680 $\Omega$ resistor to the anode of an optocoupler LED.
13 (YEL/BRN)	LEAD Pulser Input Positive. This line is connected through a 680 $\Omega$ resistor to the anode of an optocoupler LED.
18 (BLU)	Volume Pulser Negative (output). This line provides a pulse (as described above for money pulser) for each specified fraction of a unit of volume. (Used for card or key systems.)
19 (WHT/BLU)	Volume Pulser Positive. This line is normally connected to the pulser power supply positive line (+30 volts maximum, DC only) and provides power to the volume pulser line.
25 (PUR)	Gas Temperature Input 4-20mA.
26 (BLK/WHT)	Pulser Input Negative. This line is connected to the LED cathodes. Input voltage range for the pulser input wires 12 & 13 is 5-20 VDC.
<b>Wire #</b>	<b>Data Communications Lines</b>
9 (PNK)	Talk-To-Pump. This line is connected to the appropriate terminal on the “TTP” terminal block of a Concept 5000 control box or MCIU* or to the diode board of a Micro 2RP system, and carries messages from the console to the dispenser.
10 (TAN)	Talk-To-Console. This line is connected to the “TTC” terminal block of a Concept 5000 control box or MCIU and carries messages from the dispenser to the console.
16 (GRN)	Data Channel Common. This line is connected to the “DCC” terminal block of a Concept 5000 control box or MCIU* or to the diode board of a Micro 2RP system.
17 (WHT/BRN)	RS-422 Positive Input.

\* Separate installation manual (247AY00.INS R00 – North American) is available with all Kraus Group Inc. MCIU’s (*Micon Communication Interface Units*). See Table 4, page 15 of this manual for summary of communications interface connections.



4.2.1 FIGURE 11 - WIRING DIAGRAM - NORTH AMERICAN

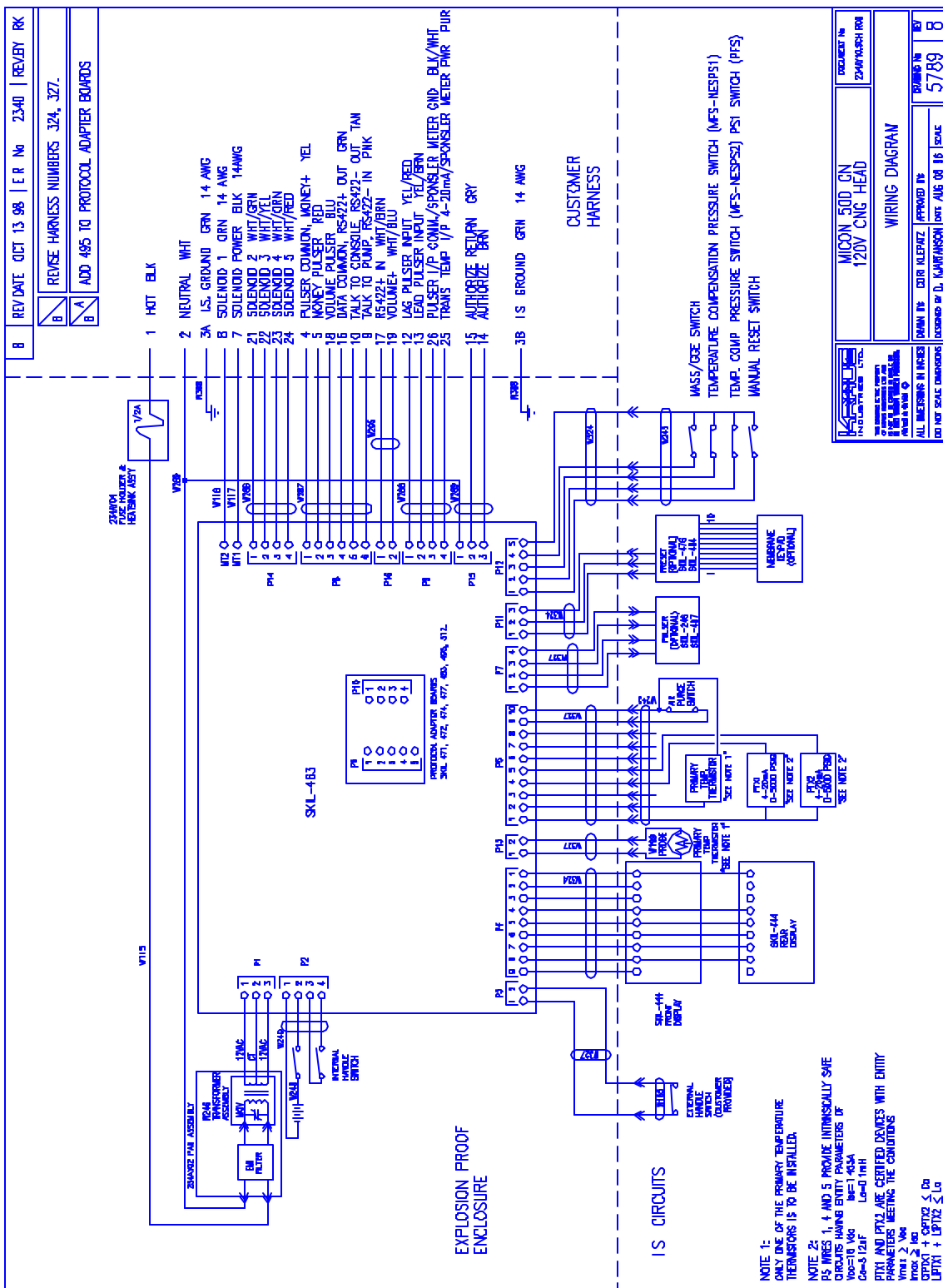

### 4.3 WIRING DETAIL - EUROPEAN

<b>Table 3: MICON 500C Wiring Detail (European) Reference: Drawing #5799-4, page 14</b>	
<b>Wire #</b>	<b>230 VAC Lines - (metric type 24 conductor shielded cable)</b>
YEL/GRN	Earth. This line is connected internally to the casting and must be connected to the service ground.
1	230 VAC head power hot line. If power is interrupted on this line, the head will go into standby and power-fail modes.
2	Neutral for head power and main board authorize/authorize request circuit.
3	Sequencing Output #1
4	230 VAC Sequencing Power
5	Sequencing Output #2
6	Sequencing Output #3
7	Hose Evacuation Solenoid/Valve Home
8	Alarm Output
19	Authorize Output. When 230 VAC is applied to wire #20 and the handle switch is ON, 230 VAC will be present on this line. (3 Amp. maximum load)
20	Authorize Input. Application of 230 VAC will "authorize" the MICON 500C to dispense product. When the handle switch is turned ON, the MICON 500C applies a 14 k $\Omega$ capacitive reactance between this line and wire #2 to serve as an authorize request load for Kraus Group Inc. Self-Serve equipment. External equipment may be used to provide an authorization signal to the Micon 500LN Electronic Register provided that both units are controlled through a common circuit breaker.
<b>Wire #</b>	<b>Low Voltage Lines</b>
9	Money Pulser Positive. This line is normally connected to the pulser power supply positive line (+30 volts maximum, DC only) and provides power to the money pulser line.
10	Money Pulser Negative (output). The MICON 500C will source a maximum of 100 mA from the money pulser positive (#9) to this line to form a pulse once for each penny of product dispensed. (Used with KRAUS MONITOR and MICRO consoles.)
11	Volume Pulser Negative (output). This line provides a pulse (as described above for money pulser) for each specified fraction of a unit of volume. (Used for card or key systems.)
15	LAG Pulser Input Positive. This line is connected through a 680 $\Omega$ resistor to the anode of an optocoupler LED.
16	LEAD Pulser Input Positive. This line is connected through a 680 $\Omega$ resistor to the anode of an optocoupler LED.
17	Pulser Input Negative. This line is connected to the LED cathodes. Input voltage range for the pulser input wires 15 & 16 is 5-20 VDC.
18	Gas Temperature Input 4-20mA.
22	Volume Pulser Positive. This line is normally connected to the pulser power supply positive line (+30 volts maximum, DC only) and provides power to the volume pulser line.
<b>Wire #</b>	<b>Data Communications Lines</b>
12	Data Channel Common. This line is connected to the "DCC" terminal block of a Concept 5000 control box or MCIU** or to the diode board of a Micro 2RP system.
13	Talk-To-Console. This line is connected to the "TTC" terminal block of a Concept 5000 control box or MCIU** and carries messages from the dispenser to the console.
14	Talk-To-Pump. This line is connected to the appropriate terminal on the "TTP" terminal block of a Concept 5000 control box or MCIU** or to the diode board of a Micro 2RP system and carries messages from the console to the dispenser.
21	RS-422 Positive Input.

\*\* Separate installation guide (247AY01.INS R00 – European) is available with all Kraus Group Inc. MCIU's: *Micon Communication Interface Units*. See Table 5, page 15 of this manual for summary of communications interface connections.



## 4.4 COMMUNICATION INTERFACE CONNECTIONS

Tables 4 and 5 below describe communication interface connections for the following interface options:

- Tokheim Interface
- Gilbarco Interface
- Tatsuno Interface
- RS-422 Interface
- RS-232 Interface
- Kraus MNET Interface

**TABLE 4 – COMMUNICATIONS INTERFACE CONNECTIONS FOR THE MICON 500CN (NORTH AMERICAN)**

Customer Harness Wire #	Tokheim Interface	Gilbarco 2-Wire Interface	Tatsuno Interface	RS-422 Interface	RS-232 Interface	Kraus MNET Interface
16	DCC	Not used	Not used	OUT “+”	Gnd	DCC
10	TTC	2-wire “+”	“+”	OUT “-”	Tx	TTC
9	TTD	2-wire “-”	“-”	IN “-”	Rx	TTP
17	Not used	Not used	Not used	IN “+”	Not used	Not used

**TABLE 5 – COMMUNICATIONS INTERFACE CONNECTIONS FOR THE MICON 500CE (EUROPEAN)**

Customer Cable Wire #	Tokheim Interface	Gilbarco 2-Wire Interface	Tatsuno Interface	RS-422 Interface	RS-232 Interface	Kraus MNET Interface
12	DCC	Not used	Not used	OUT “+”	Gnd	DCC
13	TTC	2-wire “+”	“+”	OUT “-”	Tx	TTC
14	TTD	2-wire “-”	“-”	IN “-”	Rx	TTP
21	Not used	Not used	Not used	IN “+”	Not used	Not used

## 5.0 POST INSTALLATION CHECK

After completing the installation of the MICON and checking all wiring connections, correct operation should be verified as follows:

1. Enter a price, as described below (also described in section 6.2.2 – Setting Prices, page 19).
  - a) Go to breaker box and turn OFF AC power to MICON 500C electronic pumphead being serviced. **Caution: Ensure breaker box does not feed power to equipment which should remain ON.**  
  
MICON display should be flashing.  
  
If display is not flashing, unit is in *sleep* mode. To correct this, turn handle ON and OFF. Display will start flashing.
  - b) Take the MICON hand held communicator and go to the front display of the MICON 500C electronic pumphead display.
  - c) Aim the communicator at the optical sensor (oval hole  ) at right of price display on MICON 500C.

**FIGURE 13**

**PRICE SETTING  
USING THE MICON  
COMMUNICATOR**

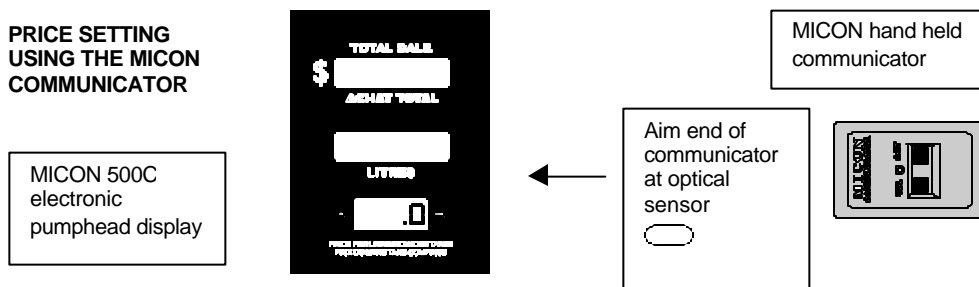

- d) To set prices :
  - While aiming the communicator's transmitter (located on the end of the unit) at the MICON 500C optical display sensor, press and hold the "SET" until the display increments to the desired number.
  - Use the "SEL" key to select the next digit to be changed. Press and hold the "SET" key until the display increments the desired number.
2. After entering a price, turn ON the 120 VAC (230 VAC European) MICON head power.
3. Place the dispenser handle in the OFF position. Turn ON dispenser sequencing power and ensure that no product can be dispensed.
4. **If card lock equipment is being used**, place the dispenser handle in the ON position. Authorize the MICON with the self serve equipment. This is normally done by inserting the appropriate card into the card terminal, then entering data (i.e., i.d. number, mileage, etc.) as required. The authorization signal received by the card terminal is sent to the MICON 500C head via input wire #14 (N. American) or #20 (European).

5. **For stand alone operation**, turn ON the dispenser handle. The authorization in this case is bypassed and the main board receives a direct signal. The display resets and the main flow valve is signaled by the MICON to open and commence fuel flow.
6. When resetting, displays should flash to all 8's momentarily, go blank, then return to zero. Now the solenoid valve controlling fuel flow should energize.
7. Place the dispenser handle in the **OFF** position.

**This completes the post installation check. If the unit does not function as described above, contact your factory or service representative.**

## 6.0 MICON 500C OPERATION

### 6.1 CONSOLE ACCESSING FOR PRICE CHANGING: MCIU

The method used to set prices to MICON 500C electronic pumpheads is dependent upon the type of self serve consoles employed.

- If you are using **Kraus Group Inc. Monitor 4 Console Systems**, refer to sections 6.2.1-Reading Totalizers (next page) and 6.2.2 – Setting Prices, page 19 for information regarding price change and reading of totalizers.
- If you are using a **Kraus Group Inc. Micon Communication Interface Unit (MCIU)**, MICON 500C totalizers and prices may be accessed through the console. Refer to owner's manual for details.



**If it is necessary to place the station in manual mode of operation, all of the affected dispensers must be “reset”:**

1. Place the console Emergency switch in the Emergency position and wait for all MICON 500C registers to go blank.
2. Return the Emergency switch to the normal position and place the manual switch in the manual position. The station may now be operated in the manual mode.
3. Manual mode switch switches AC power to line #14 (North American) or line #20 (European: authorize). *In manual mode when emergency switch in position, AC power is removed from solenoid power line.*

## 6.2 MICON 500C COMMUNICATOR OPERATION

The hand held communicator (part # MC 200D, available as an option) allows the reading of dollar and volume totals and price setting, as described below. The communicator can also be used as a troubleshooting tool to obtain current readings of product flow rate, temperature and pressure (see section 6.2.3, page 20).

### 6.2.1 READING TOTALIZERS ON A SINGLE TIER DISPENSER

(SINGLE TIER: FOR TWO TIER TOTALIZER READING, GO TO PAGE 23.)

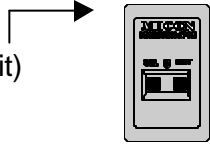
1. Ensure the dispenser handle is in the **OFF** position, and the 120 VAC (230 VAC European) MICON head power is turned ON.
2. Aim the communicator's transmitter (located on the top of the unit) at the optical sensor located to the right of the price display.  

3. Depress and hold the "SEL" key on the communicator. The red indicator to the left of the price display will flash as the MICON 500C receives the communicator's signal.
4. Hold the "SEL" key until the dollar sales total is displayed. Dollars sale total uses ten digits of the dollars and volume displays preceded by the letters "d i". Refer to Figure 14, below.
5. To display volume total, depress and hold the "SEL" key until the display shows "V i" followed by the ten digit volume total. Pressing the "SEL" key repeatedly or holding it down will cause the display to switch back and forth between volume and dollars totals.

**FIGURE 14**

#### DISPLAY DOLLAR AND VOLUME TOTALS

TOTAL **DOLLAR SALES** DISPLAY  
THIS DISPLAY READS:  
**\$782564.93**



TOTAL **UNIT SALES** DISPLAY  
THIS DISPLAY READS:  
**96154.823 UNITS**



## 6.2.2 SETTING PRICES ON A SINGLE TIER DISPENSER

(SINGLE TIER: FOR TWO TIER PRICE SETTING, GO TO PAGE 22.)

1. Go to breaker box and turn OFF AC power to MICON 500C electronic pumphead being serviced. **Caution: Ensure breaker box does not feed power to equipment which should remain ON.**

MICON display should be flashing.

If display is not flashing, unit is in *sleep* mode. To correct this, turn handle ON and OFF. Display will start flashing. The dollar (top) display on the MICON 500C displays the dollar amount and “Prc 1”.

2. Take the MICON hand held communicator and go to the front display of the MICON 500C electronic pumphead.
3. Aim the communicator at the optical sensor (oval hole  ) at right of price display on MICON 500C.

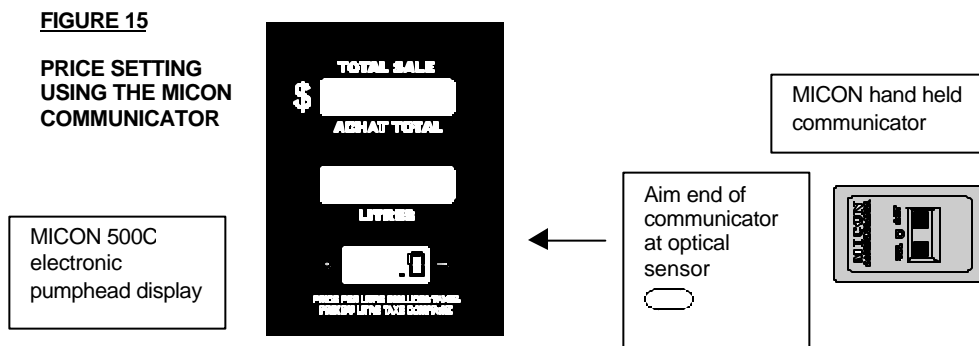

4. To set prices:
  - While aiming the communicator's transmitter (located on the end of the unit) at the MICON 500C optical display sensor, press and hold the “SET” key until the display increments to the desired number.
  - Use the “SEL” key to select the next digit to be changed. Press and hold the “SET” key until the display increments to the desired number.
  - When the correct price per unit has been entered, restore head power while handle switch remains in the OFF position.



### 6.2.3 READING CURRENT PRODUCT FLOW RATE, TEMPERATURE AND PRESSURE

To obtain current product flow rate, ambient temperature, gas temperature and/or pressure transducer readings:

1. Take the MICON hand held communicator and go to the front display of the MICON 500C electronic pumphead.
2. Aim the communicator at the optical sensor (oval hole ) at right of price display on MICON 500C.
3. To access current flow rate, temperature and pressure readings:

#### FLOW RATE READINGS

While aiming the communicator's transmitter (located on the top of the unit) at the MICON 500C optical display sensor, press the "SET" key, and observe the MICON display. The bottom of the MICON display should indicate "FLO". **The middle display will indicate the value of the flow rate, in fuel mass per minute.** The units of mass may differ if the dispenser is equipped with a turbine meter. Units are determined by the calibration of the meter output. For *Return to Normal Display* instructions, see next page.

#### AMBIENT TEMPERATURE

Follow steps 1 –3, top of this page. When the bottom MICON display indicates "FLO", press the "SET" key on the communicator a second time.

The bottom MICON display should now indicate "tA" (ambient temperature). **The middle display will indicate the ambient temperature in Fahrenheit.** For *Return to Normal Display* instructions, see next page.

#### GAS TEMPERATURE (tG)

Follow steps 1 –3, top of this page. When the bottom MICON display indicates "tA", press the "SET" key on the communicator again.

The bottom MICON display should now indicate "tG" (gas temperature). **The middle display will indicate gas temperature in Fahrenheit.** For *Return to Normal Display* instructions, see next page.

4. - (cont'd) - Accessing current flow rate, temperature and pressure readings:

### 1ST PRESSURE TRANSDUCER (P1)

Follow steps 1 –3, previous page. When the bottom MICON display indicates “tG”, press the “SET” key on the communicator again.

The bottom MICON display should now indicate “P1” (pressure transducer #1). **The middle display will indicate transducer pressure in psig.** For *Return to Normal Display* instructions, see below.

### 2<sup>ND</sup> PRESSURE TRANSDUCER (P2)

Follow steps 1 –3, previous page. When the bottom MICON display indicates “P1”, press the “SET” key on the communicator again.

The bottom MICON display should now indicate “P2” (pressure transducer #2). **The middle display will indicate pressure at a second transducer in psig.** For *Return to Normal Display* instructions, see below.



NOTE

The purpose of having a second pressure transducer is to back up the primary pressure transducer. (In some jurisdictions such a degree of backup is not required.) When a second pressure transducer has been enabled using the INFO-PAC (i.e., PTX2 setting “enab”), the MICON uses a basic compensation formula to average the readings from the two pressure transducers, and monitors the difference between the two for a maximum window of error. Refer to INFO-PAC MICON 500C Programming Manual for details.

### RETURN TO NORMAL DISPLAY

Follow steps 1 – 3, previous page. When the bottom MICON display indicates “P2”, press the “SET” key on the communicator again. MICON displays should return to indications for dollar (top), volume (middle), price per unit (bottom).

## 6.3 TWO TIER PRICE OPERATION

On MICON 500C units equipped with the two tier price option it is possible to make sales at two different prices. For example, cardholders may receive a discount from the regular price while fuel is dispensed to non-cardholders at full price. The unit maintains separate totalizers for each price of sales.

### 6.3.1 TWO TIER OPTION INSTALLATION

Two tier installation requires a connector (included with part #W392 - harness) and pricing push-button switch (part #PWP 320) or key-switch (part #Y101). To order these optional parts (listed in Table 1, page 5) contact your local service representative.

To install the two tier option:

- Connect the push button switch between the blue and orange wires on the provided connector. The push button switch can then be mounted in a 7/8" hole in the side of the dispenser.
- An optional key-switch is available, which can be used instead of, or together with, the push-button. Wire the key-switch and push-button in series, not parallel.

### 6.3.2 SETTING PRICES ON A TWO TIER DISPENSER

(FOR SINGLE TIER PRICE SETTING, GO TO PAGE 19.)

Setting prices on a two tier dispenser is the same as on single tier dispensers except that pressing the **DISCOUNT** button will change which price is being set.

1. **To set "Prc 1", which is the regular price**, proceed as on page 19 by turning OFF AC MICON 500C head power at breaker box. Display should be flashing. The dollar display on the MICON 500C displays the dollar amount and "Prc 1" at first.

Set this price by aiming the communicator's transmitter (on top of unit) at the optical sensor (oval hole ) at right of price display on MICON 500C.

Press the SEL key to select the digit to be changed, and press the SET key to increment to the desired number.

2. **To set "Prc 2", which is the discounted price**, press the DISCOUNT button located on the side of the dispenser. The dollar display on the MICON 500C will then display the dollar amount and "Prc 2" at first. "Prc 2" indicates the discounted price.

Set this price by aiming the communicator at the optical sensor (oval hole ) at right of price display on MICON 500C. Press the SEL key to select the digit to be changed, and press the SET key to increment to the desired number.

### 6.3.3 MAKING DISCOUNT PRICE SALES ON A TWO TIER DISPENSER

1. To make a discount priced sale, simply press the **DISCOUNT** push button, located on the side of the dispenser, before turning the dispenser handle ON. When the button is pressed, the discount price will be displayed. The next sale will proceed at the discount price.
  - If the DISCOUNT button is pressed by mistake and you do not wish to make a discounted sale, simply press the DISCOUNT button again and the dispenser will revert back to the regular price.
  - Pressing the DISCOUNT button while the dispenser handle is in the ON position has no effect on the dispenser.)
2. When the discounted sale is completed turn the dispenser handle to the OFF position. The regular price will again be displayed and subsequent sales will occur at the regular price.



The INFO-PAC used to monitor and program the MICON 500C pumpheads has a setting intended for use when two tier (regular and discount) pricing is in effect: PRC RESTORE (price restore). When this setting is ON (default setting), the MICON automatically reverts back to tier 1 (regular pricing) after each discounted transaction.

It is possible to set PRC RESTORE OFF, in which case the price used for the current sale is retained for the next sale. Refer to INFO-PAC MICON 500C Programming Manual for details.

#### 6.3.4 READING TOTALIZERS ON A TWO TIER DISPENSER

(FOR SINGLE TIER TOTALIZER READING, GO TO PAGE 18.)

Reading volume and dollar totals on two tier dispenser totalizers is the same as on single tier dispensers totalizers, except that pressing the **DISCOUNT** button will change which volume/dollar setting (regular or discount) is being read.

The two tier dispenser contains two sets of totalizers:

- volume and dollar totals for **regular** priced sales;
- volume and dollar totals for the **discount** priced sales.

To read the totalizers:

1. Proceed as on page 18 by turning OFF AC MICON 500C head power at breaker box. Display should be flashing. Aim the communicator's transmitter (on top of unit) at the optical sensor (oval hole ) at right of price display on MICON 500C. Press and hold the SEL key until the dollar sales total is displayed.
2. Display will show "d r" for regular dollar totals. Press the DISCOUNT button. Display will show "d | r" for discount dollar totals.
3. Press the SEL key until the display shows "v r" (regular priced volume total) or "v | r" (discount priced volume total). Press the DISCOUNT button to switch back and forth between "v r" and "v | r".
4. Press and hold the SEL to switch back and forth between dollar and volume total displays.

Manually adding regular and discount volume or dollar totals will yield grand sales totals.

**FIGURE 16**

**READING TOTALIZERS**

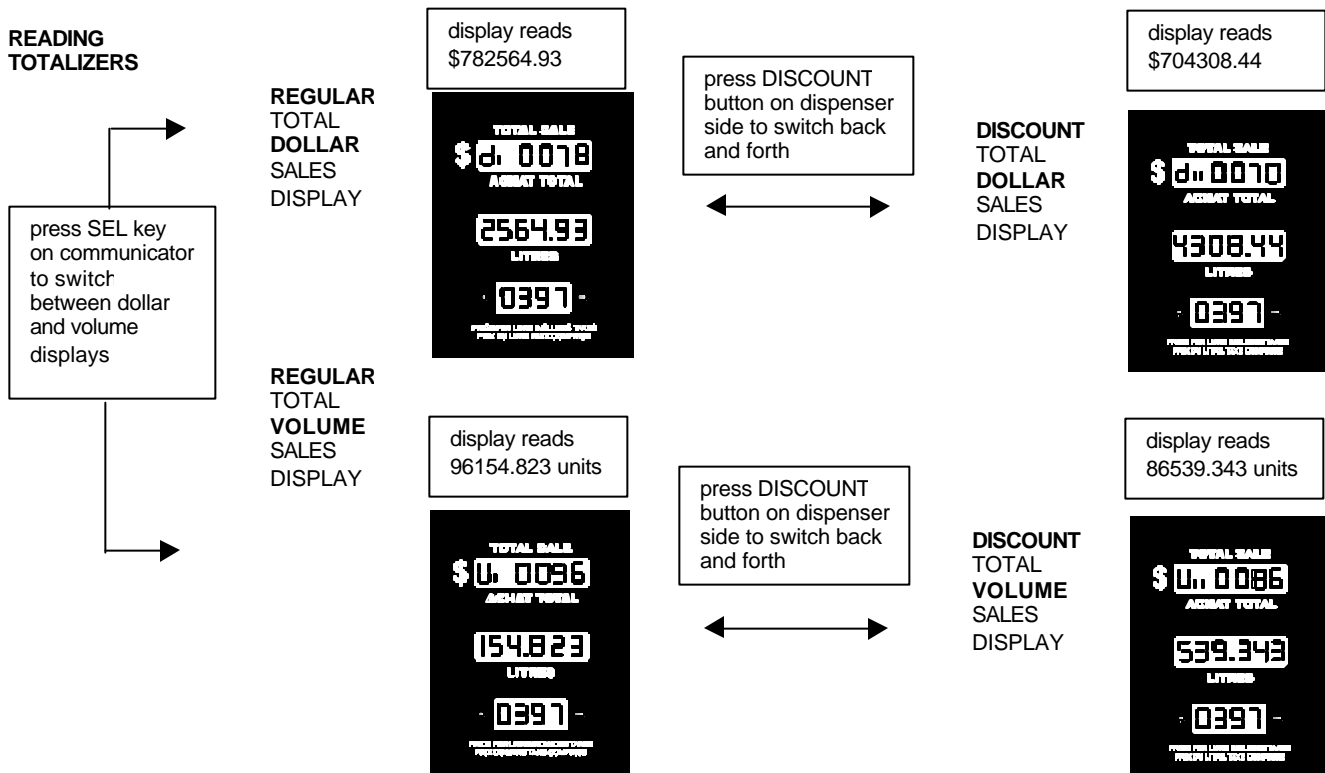

## 6.4 ELECTRONIC AUDIT TRAILS

The MICON 500C is equipped with electronic audit trails in the form of non-resettable event counters. This feature is facilitated in software, and meets the current requirements of weights & measures regulations. Indication is provided at the MICON 500C electronic pumphead of the number of changes to device configuration parameters performed with the INFO-PAC, as shown in Fig. 3, page 3.

## 7.0 MICON 500C SEQUENCING

The INFO-PAC settings relevant to switching between low, mid and high banks are shaded in Table 6 and Table 7 (below and next page). They are m500 – MIN. FLOW, MAX FLOW; m500c – FILL OPTION, IPTP FLOW 1, IPTP FLOW 2; defined on pages 26, 27.

**TABLE 6 – M500 INFO-PAC PROGRAMMABLE FEATURES (FOR CNG); SOFTWARE VERSION 3.0**

OPTION	DESCRIPTION	DEFAULT SETTINGS
<b>SETUP MODE m500</b>		
CONFIG	sets menu options to custom or default configurations	default
TEST	sets test mode ON or OFF	off
PULSER	selects pulser input source: I.S. circuit external wiring or conduit wiring	.i.s.
IN COUNT	indicates number of quadrature (input pulser) transitions per unit displayed	1000
MULTIPLIER	factor used to adjust pulser edges per unit of product (works with IN COUNT)	1
CURRENCY	selects monetary unit for currency display	dollars
VOL DISP	sets number of decimal places in the volume unit display	1.000
SUPPRESS	sets number, if any, of units of flow suppression at beginning of transaction	0.030
CONV.	metric – Imperial – US volume conversion; not for CNG applications	off
PRC RESTORE	automatically restores tier 1 price after tier 2 is used	on
NO FLOW	sets <i>no flow</i> (sale in progress but no product flow registering) timer ON	off
VOL P. QUAD	sets volume out pulser as single channel, with penny pulser option; or two channel quadrature pulser output with penny pulser disabled	off
VOL PPU	sets number of output pulses per unit	10
VOL PW	sets pulse width of output signal	4.0ms
PENNY PW	sets pulse width of penny pulse signal	4.0ms
W/M STANDARD	sets allowable pulser errors to N. American or European standards	na
CLEAR ZEROS	permits display or suppression of leading zeros in current sale	off
CONSOLE	shows type of communications protocol used (Kraus, Tokheim, Gilbarco)	kraus
PUMP ID.	sets pump address used for serial data communication	not set
GRADE	features vary according to interface manufacturer (Kraus, Tokheim, Gilbarco)	1
DISPLAY	sets current sale display interpretation; use default setting for CNG applications	normal
MASS CONV.	indicates mass of fuel sold in gasoline gallon or gasoline litre equivalents	off
HOSE SIZE	sets size of CNG dispensing hose	0.00
TURBINE	permits turbine meter option	disab
T. CALIB	sets turbine meter calibration values	10000
T. UNITS	sets final calculated units for turbine meters	1b
MIN. FLOW	flow rate used to determine whether sale is completed	00.4
MAX FLOW	excess fill threshold above which Micon 500C will end the filling transaction	030
SLOW FLOW	sets (for preset sales) when fast flow valve closes; slow flow valve only remains	0.600
START KEY	reserved for future expansion; set to default (disab) only	disab
STOP KEY	reserved for future expansion; set to default (disab) only	disab
CUST. PRESET	reserved for future expansion; set to default (disab) only	disab
P. CODE	sets personal security code for price changing	0000
TRANSMIT	transmits pump configuration info to Micon 500 head	off
RX MICON	receives Micon 500C settings from units already programmed	off

TABLE 7 – M500C INFO-PAC PROGRAMMABLE FEATURES (FOR CNG); SOFTWARE VERSION 3.0

OPTION	DESCRIPTION	DEFAULT SETTINGS
<b>SETUP MODE m500c</b>		
FILL OPTION	select fill sequencing option (3 solenoids or 1 solenoid and a main actuator)	1
MAX LINE	select 1, 2 or 3 pressurized lines	3
IPTP FLOW 1	increased pressure trip point at which low bank switches to mid bank	00.0
IPTP FLOW 2	increased pressure trip point at which mid bank switches to high bank	05.0
EXCESS FILL	permits preset mass value to terminate the fill	0100
EXCESS RESET	permits shut down on excess flow condition	auto
ALARM SET	sets which alarms will trigger an alarm output	all
COMP. SYSTEM	selects which pressure-temperature compensation system is active	mfs
FILL PRESS	sets operating compensated fill pressure (if COMP SYSTEM set to <i>pfs</i> )	p30
PRESS UNIT	sets pressure transducer scaling units (PTSU) if COMP SYSTEM set to <i>pfs</i>	psig
PRESS.SC.	scales pressure transducer 4-20 ma output (with PTSU; COMP SYSTEM <i>pfs</i> )	5000p
HEAT SCALE F.	sets compression heating scaling factor (if COMP SYSTEM set to <i>pfs</i> )	10
PTX2	sets redundant pressure transducer status (if COMP SYSTEM set to <i>pfs</i> )	disab
TRX TEMP.	permits a transducer temperature enable (if COMP SYSTEM set to <i>pfs</i> )	enab
RESTART TIME	sets delay time permitted between an end-of-fill and true fill termination	02s
MFS TIMER	sets time delay initiated each time any flow control solenoid valve is activated	02s
BLANK TIMER (displays instead of MFS TIMER if COMP. SYSTEM set to <i>pfs</i> )	sets time delay pressure readings from pressure transducers, as well as the condition of the hard limiting pressure switch, are blanked	02s
TX M500C	transmits pump configuration info to Micon 500 head	off
RX M500C	receives Micon 500C settings from units already programmed	off

## 7.1 DEFINITIONS - INFO-PAC SEQUENCING SETTINGS

### 7.1.1 MIN FLOW (minimum flow) – Table 6, page 23

This is a flow rate used to determine whether or not a sale is deemed complete. The value can range from 00.0 - 99.9 units/minute. If flow is below this value for 6 seconds or more, the sale is considered complete and all valves close. All lines turn OFF and the *sale complete* tone is given.

If the **IN COUNT** INFO-PAC setting is less than 1000 (the default value) the MIN FLOW rate must be multiplied by 10, 100 and 1000 for IN COUNT's of 100, 10 and 1 respectively. See INFO-PAC MICON 500C Programming Manual (software version: 3.0).

### 7.1.2 MAX FLOW (maximum flow) – Table 6, page 25

This flow rate determines an excess flow threshold above which the MICON 500C will cease flow. The value can range from 0 - 180 units/minute. If a flow rate above the set value is calculated, all valves close. All lines turn OFF and the *sale complete* tone is given.

If the **IN COUNT** INFO-PAC setting is less than 1000 (the default value) this MAX FLOW rate must be multiplied by 10, 100 and 1000 for IN COUNT's of 100, 10 and 1 respectively. See INFO-PAC MICON 500C Programming Manual (software version: 3.0).

### 7.1.3 IPTP FLOW 1 (increased pressure trip point – flow 1) – Table 7, page 26

This value is used to determine, while using only the low pressure line, when to open the valve for the mid pressure line. In all sequencing methods, when the flow decreases below this value (00.0 units to 99.9 units) the valve for the mid pressure line is opened.

The appropriate INFO-PAC setting (units/minute) is calculated as approximately 20 percent of mass flow meter maximum flow rate. The mass flow meter maximum flow rate is obtainable from the manufacturer's specifications. See INFO-PAC MICON 500C Programming Manual (software version: 3.0).

### 7.1.4 IPTP FLOW 2 (increased pressure trip point – flow 2) – Table 7, page 26

This value is used to determine, while using only the low and mid pressure lines, when to open the valve for the high pressure line. In all sequencing methods, when the flow decreases below this value (00.0 units to 99.9 units) the valve for the high pressure line is opened.

The appropriate INFO-PAC setting (units/minute) is calculated as approximately 10 percent of mass flow meter maximum flow rate. The mass flow meter maximum flow rate is obtainable from the manufacturer's specifications. See INFO-PAC MICON 500C Programming Manual (software version: 3.0).

### 7.1.5 FILL OPTION – Table 7, page 26

This value defines if the mid and high banks are controlled by solenoid or motor actuator values.



### 7.1.5.1 FILL OPTION 1

#### Option 1 (default):

This option is for setups using 3 solenoids to control flow from low/mid/high banks. The solenoids are connected as follows:

EUROPEAN	NORTH AMERICAN	TABLE 8 WIRE CONNECTIONS FILL OPTION 1
230 VAC LINES	120 VAC LINES	
METRIC TYPE	18 AWG	SOLENOID
wire 3	wire 8 (orange)	connects to low bank
wire 4	wire 7 (black)	connects to sequencing power
wire 5	wire 21 (white/green)	connects to mid bank
wire 6	wire 22 (white/yellow)	connects to high bank

**If all three lines are not being used, remove solenoid connections, starting from the highest bank.**

At the start of the fill, both the low bank valve and the high bank valve are opened. After flow starts and the optional *pfs* initialization (see section 8.3, page 34) is complete, flow is continued through the low bank valve. The flow is allowed to stabilize for ¼ second and then the flow is measured over the next ¼ second. If this flow is below MIN. FLOW (m500 setting), then the mid bank valve is opened immediately. Otherwise sequencing continues comparing the flow rate with IPTP1 (Increase Pressure Trip Point 1) to determine when to open the mid bank valve (see Figure 17, next page). When the mid bank valve has been opened, the flow is again allowed to stabilize for ¼ second and then flow is measured over the next ¼ second. If the flow is less than the MIN. FLOW (m500 setting), the high pressure valve is also opened and the sale is allowed to complete; otherwise sequencing continues comparing the flow rate with IPTP2 (Increase Pressure Trip Point 2) to determine when to open the high bank valve.

7.1.5.1 FILL OPTION 1 (CONT'D)

**FIGURE 17**  
**FILL OPTION 1**

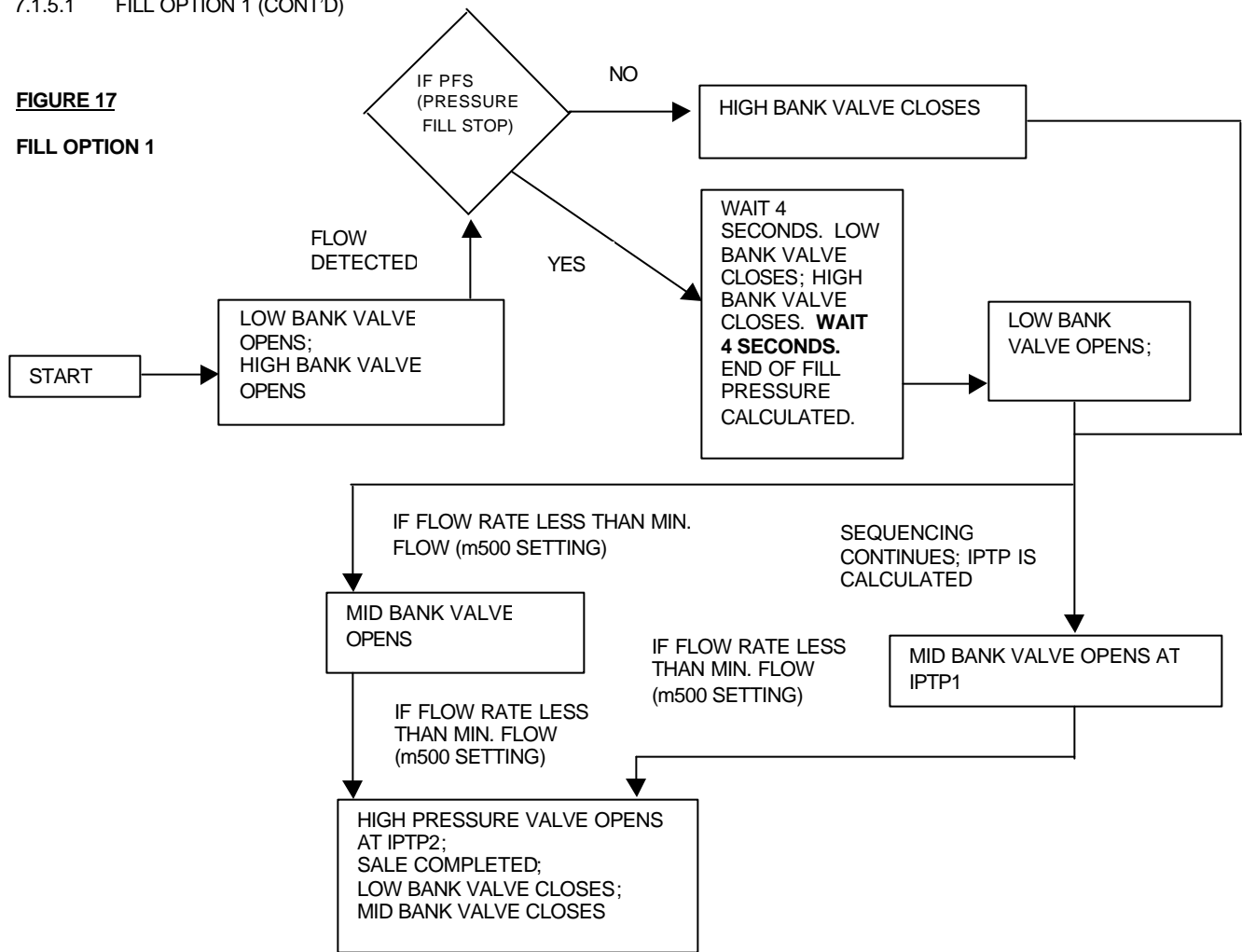

**7.1.5.2 FILL OPTION 2**

**Option 2:**

This option is for settings using a three position actuator valve and one main solenoid valve. Connect as shown:

EUROPEAN	NORTH AMERICAN	TABLE 9 WIRE CONNECTIONS FILL OPTION 2
230 VAC LINES	120 VAC LINES	
METRIC TYPE	18 AWG	<b>SOLENOID</b>
wire 3	<b>wire 8 (orange)</b>	connects to main solenoid valve
wire 4	<b>wire 7 (black)</b>	connects to sequencing power
wire 5	<b>wire 21 (white/green)</b>	connects to actuator valve mid bank line position
wire 6	<b>wire 22 (white/yellow)</b>	connects to actuator valve high bank line position
wire 7	<b>wire 23 (white/orange)</b>	connects to motor actuator valve HOME position

At the start of the sale, the main valve is opened and the motor actuator is advanced to the high bank position. When flow starts and the optional *pfs* initialization has completed, the flow continues with only the main solenoid valve open. The flow will be allowed to stabilize for 2 seconds. Flow will continue until the IPTP1 or the MIN. FLOW is reached; then the motor actuator will advance to activate the mid bank line. Once again the flow rate will be allowed to stabilize for 2 seconds. Flow will continue until IPTP2 or the MIN. FLOW has been reached, then the motor actuator will be advanced to the high bank line position.

Flow will continue until the end of sale (flow rate below the MIN. FLOW level), when the main flow solenoid will be closed and the motor actuator valve returns to the home position.



NOTE

Alarm output is disabled with this fill option.

#### **Motor Actuator Options:**

If, at any time, the position of the motor actuator valve is unknown (i.e., at first power up), the valve will be reset to the HOME position by activating the HOME output for 10 seconds.

7.1.5.2 FILL OPTION 2 (CONT'D)

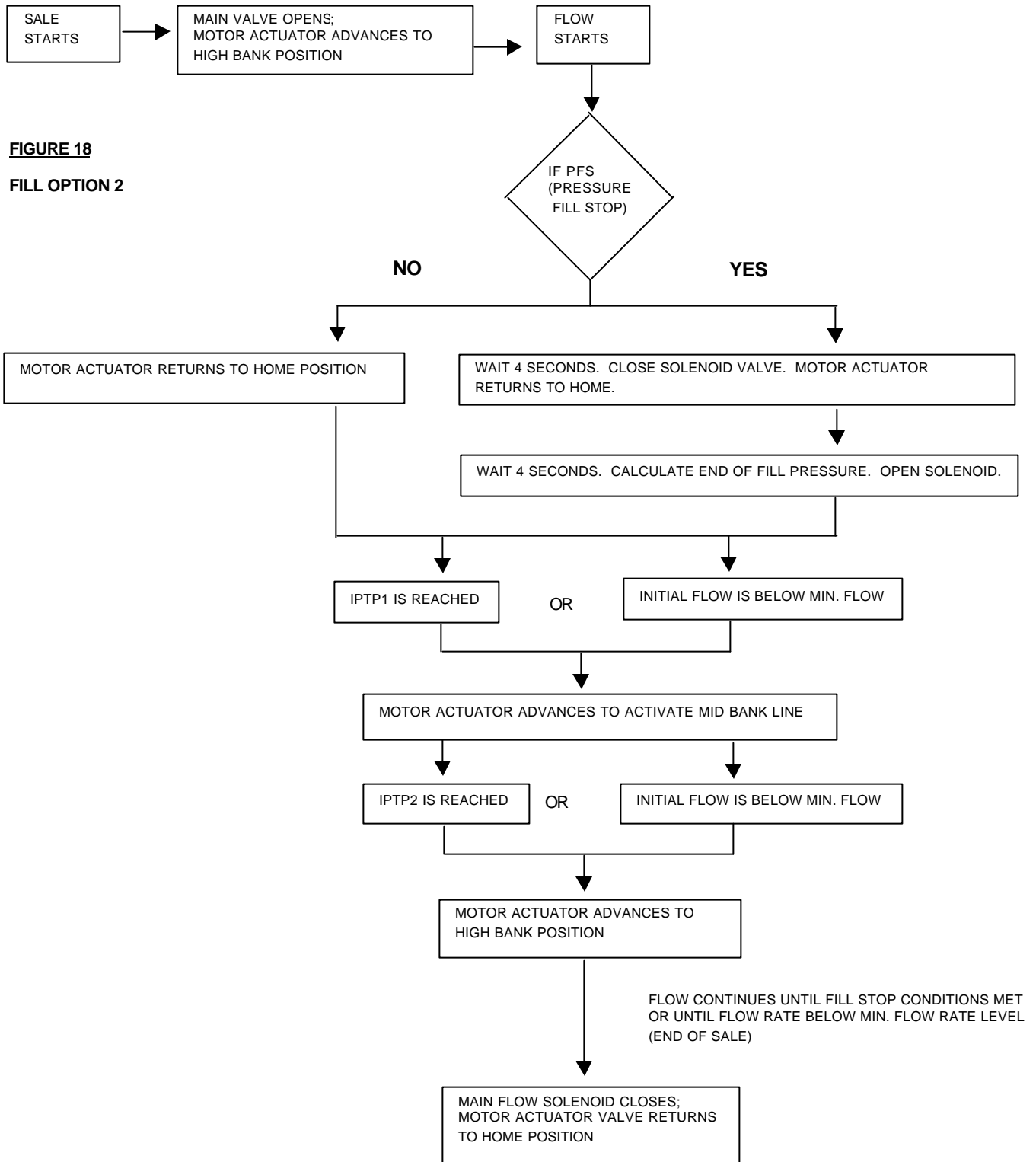

**FIGURE 18**  
**FILL OPTION 2**

## 8.0 PFS 3000 / 3600 PRESSURE-TEMPERATURE COMPENSATION SYSTEM

### 8.1 GENERAL DESCRIPTION

The PFS 3000 / 3600 system is an electronic ambient temperature compensation system for CNG (compressed natural gas). It corrects final fill pressures for ambient temperature according to a series of algorithms based on the ideal gas law:

$$\gamma = \frac{p}{RT}$$

SPECIFIC WEIGHT OF GAS =  $\frac{\text{ABSOLUTE PRESSURE OF GAS}}{(\text{GAS CONSTANT FOR GAS TYPE}) (\text{ABSOLUTE TEMPERATURE OF GAS})}$

This system is based primarily in software, but employs a series of analog and digital inputs to interface the transducer inputs to the system. The control output is the same control valve as the main shut-off solenoid valve, with some additional annunciation outputs.

The PFS 3000 system, as incorporated into the MICON 500C head, meets both North American and European design requirements. Alarms are a key function of this system, including alarms generated externally which the MICON 500C must respond to, and internal faults which must be appropriately handled by the MICON 500C, according to codes and regulations.

The total inputs consist of 4 analog and 5 digital and/or triggering inputs. Analog inputs include 2 pressure transducers, 1 temperature thermistor, and 1 temperature output from the mass flow meter. The digital inputs are simple logic level switch inputs. Various degrees of protection are available and are identified in the hardware description in Table 10, next page.

## 8.2 HARDWARE

### 8.2.1 HARDWARE INPUTS

**TABLE 10 – PFS 3000 / 3600 SYSTEM HARDWARE INPUTS**

INPUT	TYPE	ELEMENT	RESOLUTION	PROTECTION	DESCRIPTION
<b>PTX1</b>	analog 4-20 ma	pressure transducer	12 bit A/D	intrinsically safe	This is main (default) dispenser pressure transducer.
<b>PTX2</b>	analog 4-20 ma	pressure transducer	12 bit A/D	intrinsically safe	This is optional backup transducer for applications requiring redundancy.
<b>TA</b>	resistive temperature probe (Kraus optional part # W 199)	thermistor	1° F	intrinsically safe	Used for ambient temperature measurement.
<b>TT</b>	analog 4-20 ma	temperature transducer	1° F	intrinsically safe	Transmitted temperature transducer (typically supplied through mass flow meter). If disabled, system uses ambient temperature only.
<b>PS1</b>	digital switch contact	pressure switch	N/A	intrinsically safe	This is non-compensated hard limiting pressure switch. (When COMP. SYSTEM <b>mfs</b> is selected with INFO-PAC, PS1 becomes a temperature compensation switch instead.)
<b>MFSPS2</b>	digital switch contact	temperature-compensated pressure switch	N/A	intrinsically safe	Active only when COMP. SYSTEM <b>mfs</b> compensation system INFO-PAC setting selected (i.e., temp. compensation pressure switches); replaces MICON 500C inputs for pressure transducers.
<b>MRST</b>	digital switch contact	momentary push-button switch	N/A	intrinsically safe	Serves as manual reset switch to reset MICON 500C after certain alarms or faults. Install in <b>lockable</b> area, such as dispenser cabinet. <b>Only authorized service personnel may access and reset.</b>
<b>AIR</b>	digital switch contact	pressure switch (or equivalent input)	N/A	intrinsically safe	This is kill switch for dispenser air purge and/or pressurization system.
<b>MASS/GGE Display Switch</b>	digital switch contact	momentary push button switch	N/A	intrinsically safe	Serves as a manual mass display to convert GGE or GE to lb or kg.

### 8.3 SOFTWARE

This system employs algorithms based on ideal gas law equations to predict an end-of-fill final pressure. Variables such as the dynamic gas pressure, ambient temperature and gas temperature are utilized. The system basically functions as follows:

1. When each fill is authorized, the main flow and high bank valves are opened, recording the dispensed amounts.
2. After 4 seconds, both valves are closed.
3. After waiting an additional 4 seconds for the pressure to stabilize, the initial pressure transducer reading is recorded.
4. The main flow valve is again opened and the fill continues as per normal. The final fill pressure is monitored throughout the sale.

The final fill pressure is limited to the absolute pressure hard value. The absolute pressure is calculated as 1.2 times the operating pressure:

**TABLE 11 – ABSOLUTE PRESSURE**

OPERATING PRESSURE	MULTIPLICATION FACTOR	ABSOLUTE PRESSURE: FINAL FILL PRESSURE CANNOT EXCEED THIS VALUE.
3000 psig	multiply by 1.2	3600 psig
3600 psig	multiply by 1.2	4320 psig

At the final fill pressure, the fill terminates, regardless of the state of the fill. However, the restart timeout mechanism will be allowed to take its course, just in case the pressure transducer reading is falsely high and settles below the target fill valve pressure. See section 8.5 - Restart Timeout & Noise Blanking, page 35.

The initial pressure referred to in step 3 above (i.e., after valves have closed and pressure stabilized) is used for two functions:

- First, if it exceeds 90% of the predicted final target fill pressure, the fill is not allowed to begin.
- Initial pressure is also used by the main algorithm to predict falsely high pressure readings due to compression heating of cylinder gas, and to provide an adjustable correction factor to compensate for this.

## 8.4 END-OF-FILL DETERMINANTS

Following is a list of conditions which can terminate a fill (i.e., reset the register):

1. **The pressure at the dispenser transducer has reached the predicted final fill pressure, and the fill terminates under normal operating conditions.** The fill is terminated once the restart timeout times out.
2. **The absolute pressure is reached.** If the final fill pressure reaches this pressure, the fill must be terminated regardless of how full the vehicle actually is. However, this is not an emergency condition, and the restart timeout is allowed to take place, to see if the pressure again drops below the absolute value. If it does, then the restart timeout will allow the fill to resume. Otherwise, the fill fully terminates without any special annunciations.
3. **The pressure switch triggers.** Where the pressure switch PSI is installed, it is set for a switching pressure equal to the absolute pressure value. As can be seen, it serves as a mechanical backup for the pressure transducers.

As in #2 above, if the final fill pressure reaches the absolute pressure, the fill must be terminated regardless of how full the vehicle actually is. This is not an emergency condition, and the restart timeout is allowed to take place, to see if the pressure again drops below the absolute value. If it does, then the restart timeout will allow the fill to resume. Otherwise, the fill fully terminates without any special annunciations.

4. **If the customer turns OFF the handle switch,** the fill is considered terminated immediately, with no restart timeout.
5. **'No flow' timeout.** This feature is settable using the INFO-PAC transmitter, and controls the length of time MICON 500C keeps motor and solenoid valve ON if a sale is in progress but there is no product flow being registered. It can be set from 15 seconds to 4 minutes, 15 seconds. See INFO-PAC MICON 500C Programming Manual (software version: 3.0).
6. **If the initial vehicle cylinder pressure exceeds 90% of the final target pressure as calculated,** a fill is not permitted to proceed, as the vehicle is too close to full to assure a safe end-of-fill.
7. **Faults or alarms.** The MICON hardware or software may generate an internal or receive an external fault or alarm. Alarm shutdown triggers are identified separately in section 8.10 – Alarms (Table 12), page 40, with appropriate reset actions. Alarm triggers include the Excess Flow and Excess Fill features, settable using the INFO-PAC transmitter.

## 8.5 RESTART TIMEOUT & NOISE BLANKING

In certain common situations, the dispenser pressure transducer may temporarily see a pressure higher than the actual pressure of the vehicle cylinder being filled. In this case, the fill will stop when the pressure-temperature compensation system has determined a normal end of-fill, as described in scenarios 1, 2, and 3 above. The fill will then be given a chance to restart and continue if the static pressure at the transducer (which is actually the static vehicle cylinder pressure) settles or falls below the end-of-fill pressure. This is accomplished by two time delays, which are preset in the INFO-PAC: the *noise blanking delay* and the *restart timeout delay*.



The restart timeout and noise blanking work together to stop and restart the fill as many times as necessary to ensure that the end-of-fill is at an accurate pressure before the fill is completely terminated.

### **NOISE BLANKING DELAY:**

The Noise Blanking Delay is a preset time delay which is immediately activated every time any flow control valves are opened. This delay is intended to blank or ignore pressure spikes or pressure "noises" which typically occur at the opening of the main flow valve, or at bank switchovers, and which dissipate rapidly once a stable flow is achieved.

### **RESTART TIMEOUT:**

The restart timeout is a time delay which is automatically activated when the pressure-temperature compensation system has determined a normal end of-fill, as described in scenarios 1, 2, and 3 on preceding page. The restart timeout gives the system a chance to reach a lower settled pressure than the end-of-fill condition, and continue the fill. In this way, the system essentially ensures the dispenser pressure transducers were reading an accurate end-of-fill condition when they stopped the fill, and were not reading a false higher pressure due to such elements as extreme flow restrictions, etc. If, after the restart timeout, the pressure is still at or above the end-of-fill pressure, the fill is then fully terminated.

## **8.6 EXCESS FLOW / EXCESS FILL\***

\* EXCESS FLOW AND EXCESS FILL SETTINGS ARE CONFIGURED TO MICON 500C PUMPHEADS USING THE INFO-PAC. THE EXCESS FILL SETTING IS DEFINED AS **EXCESS RESET** ON INFO-PACS USING SOFTWARE VERSIONS 3.0 AND UP.

Various jurisdictions associate different levels of importance to these features for safety shutdowns, so this system is fully adjustable and able to respond to a variety of code requirements.

### **EXCESS FLOW:**

The Excess Flow safety feature is virtually the same as a "high flow cutoff". A maximum flow value (in units of calibration per minute) is preset using the INFO-PAC transmitter. When the measured flow rate exceeds this preset value, a system shutdown occurs, with two selectable methods of reset available.

#### Reset Method 1:

This option is intended for use in jurisdictions where an excess flow feature is not considered a necessity. When an excess flow condition occurs, a shutdown terminates the fill. A reset of the handle switch restores the "normal" operational state.

### Reset Method 2:

This option terminates the fill on an excess flow shutdown. The MRST (manual reset switch) input requires resetting before the system returns to "normal" operational state.

### EXCESS FILL (OR EXCESS RESET):

The Excess Fill feature is an additional safety shutdown with limited applications. This feature is useful for detecting hose ruptures. The Excess Fill value is the maximum possible quantity of fuel which can be dispensed for the particular filling application. It is preset using the INFO-PAC transmitter, using units which match the current MICON 500C calibration units.

The software continuously monitors the actual quantity of fuel delivered and compares it to the preset excess fill value. When the amount delivered exceeds this value, an excess fill alarm is triggered, and the MICON 500C is shut down. Because the applications for this system are limited, the Excess Fill system can only be reset manually through the MRST (manual reset switch) input.

The Excess Fill feature is particularly useful for fixed applications such as transit refueling. Transit buses have a calculated standard maximum amount of fuel that can be accommodated, before it can be assumed that a hose is broken or there is a serious leak.

## 8.7 OPTIONAL PARAMETERS

There are optional parameters settable using the INFO-PAC transmitter associated with use of:

- a) dispensers using turbine-type meters and/or
- b) compensation systems using pressure transducers and temperature probes

A **TURBINE** meter enable setting on the INFO-PAC is for CNG dispensers using volumetric turbine-type meters. Appropriate hardware modifications have to be performed on the MICON 500C mainboard, including a fuse installation, for the TURBINE setting to take effect.

If a) above is selected, b) must also be selected. Related settings are described below. See INFO-PAC MICON 500C Programming Manual (software version: 3.0) for further details.

- **COMP. SYSTEM pfs** (compensation system; pressure fill stop)  
This option is for systems functioning using pressure transducers and temperature probes.
- **FILL PRESS (fill pressure)**  
This option permits setting of Operating Compensated Fill Pressure, and works only in conjunction with COMP. SYSTEM pfs.
- **PRESS UNIT (pressure units)**  
This option permits setting of Pressure Transducer Scaling Units (PTSU). This setting selects the units used for all pressure interfaces in the system (i.e., psig, barg). It works only in conjunction with COMP. SYSTEM pfs.

➤ **PRESS. SC. (pressure scaling)**

This option is used to properly scale the pressure transducer 4 mA to 20 mA, depending on the pressure units selected (i.e., psig, barg). It works in conjunction with Pressure Transducer Scaling Units (PTSU) and COMP. SYSTEM pfs.

➤ **HEAT SCALE**

This option sets the Compression Heating Scaling Factor. It works only in conjunction with COMP. SYSTEM pfs. This (no unit) scaling factor is used to factor the difference between the initial pressure and the target fill pressure. This calculation creates a pressure value which is added to the final fill pressure to allow for falsely high vehicle cylinder pressure readings due to compression heating within the vehicle cylinders.

➤ **PTX2 (pressure transducer status – redundant)**

The purpose of the second pressure transducer is to back up the primary pressure transducer. See section 8.9, System Redundancies, page 39. It works only in conjunction with COMP. SYSTEM pfs.

➤ **TRX TEMP. (transmit temperature)**

This option permits a transducer temperature enable. When enabled, the ambient temperature is averaged with the actual gas temperature for use in the basic compensation formula. When disabled, only the ambient temperature is used.

## 8.8 FAILURE PROTECTIONS

Security is available for all mechanical and/or electrical failures of input or output devices, which could otherwise adversely affect the safety of the equipment. This protection is available for all devices connected to this system.

Since each of the following failures are mechanical or electrical in nature, the resulting action is a system shutdown, with manual reset only through the MRST (manual reset switch) input and/or push-button on the main board.

### 1. Pressure Transducers:

These will fail either fully open or fully closed. For this reason, when either of these conditions are detected it is considered a major fault.

The pressure transducers are scaled for an output of 4 to 20 mA. However, the system hardware accepts inputs over a range of about 0 to 24 mA, with this 4 mA margin on either end used for transducer failure detection. The software recognizes that any value outside of the 4 to 20 mA range is an automatic failure.

### 2. Mass Flow Meter Gas Temperature Transducer (optional):

Since this is a 4 to 20 mA device, the same hardware input margins apply as for pressure transducers. The mass flow meter output will typically swing to 2 mA or 22 mA on failure.

### 3. Ambient Temperature Probe:

This is not a 4 to 20 mA device. However, much in the manner of the Kraus ATC probe failure detection, the system is able to detect a fault and cause a shutdown. Normally this means if the temperature goes beyond the range of  $-50^{\circ}\text{C}$  to  $+50^{\circ}\text{C}$ , a shutdown will occur.

## 8.9 SYSTEM REDUNDANCIES

Some jurisdictions require redundancy of the key pressure sensing elements. For these applications, a second pressure transducer input has been added. The key element of redundant pressure transducers is the ability to verify proper transducer operation. PTX2 (pressure transducer two) is used in conjunction with PTX1 (pressure transducer one) to find an average value for PTX for comparison against the target pressure.

In some jurisdictions backup from a second pressure transducer is not required. Through settings on the INFO-PAC transmitter, the system is able to enable or disable use of the redundant pressure transducer. When disabled, it is completely ignored. When enabled, the basic compensation formula averages the readings from the two pressure transducers, and monitors the difference between the two for a maximum window of error.

A deviation greater than 3 percent between PTX2 and PTX1 readings is considered a major fault, triggering an immediate system shutdown, with manual reset only through the MRST (manual reset switch) input.

## 8.10 ALARMS

Table 12 next page displays conditions which result in an alarm and shutdown of the system.

- Shutdowns which can be reset only through the manual MRST (manual reset switch) input or push-button will always register on the ALARM output.
- Shutdowns which are automatically reset (e.g., with the handle switch) will only register on the ALARM output if the INFO-PAC ALARM option is set to "all". The other INFO-PAC ALARM setting is "man", which enables a manual reset only.

During a system shutdown due to an alarm, the buzzer is set to operate on a 1 second ON/OFF cycle interval. The buzzer stops sounding when the alarm is reset.

**TABLE 12 – ALARM SHUTDOWN TRIGGERS AND RESET ACTIONS**

FAULT	RESULT	TO RESET ALARM
TRANSDUCER OUT OF RANGE	SHUTDOWN	Activate MRST input and/or push button on main board.
EXCESS FLOW	SHUTDOWN	INFOPAC preset
EXCESS FILL	SHUTDOWN	Activate MRST input and/or push button on main board.
PTX1 VS PTX2 ERROR	SHUTDOWN	Activate MRST input and/or push button on main board.
LOSS OF AIR PURGE OR PRESSURE	SHUTDOWN	Activate MRST input and/or push button on main board.
PULSER DISCONNECT/LOSS OF QUADRATURE	SHUTDOWN	Reset the handle switch.

**9.0 MICON 500C FAULT CODES**

Should an operational error occur while using the MICON 500C, a fault code will show in the PPU (price per unit) display, alternating with the price at 1 second intervals.

Tables 13 and 14 on following pages list fault codes and associated troubleshooting recommendations.

**FIGURE 19**

**FAULT CODE IN PRICE DISPLAY**



← Fault codes listed Tables 13 and 14, pages 41 to 42 show in MICON 500C *price display*.

**TABLE 13 – MICON 500C FAULT CODES**

DISPLAY CODE	DESCRIPTION OF FAULT	PROBABLE CAUSE	RECOMMENDED ACTION	TO CLEAR FAULT CONDITION
<b>CO26</b>	PULSER FAULT	Missing or disconnected pulser.	Check customer harness lead electrical connections (see section 4.2 – American, pp 11-12; section 4.3 - European, pp 13-14)	1. Correct source of error. 2. Turn handle switch OFF, then ON.
<b>CO27</b>	PULSER BUFFER OVERFLOW FAULT	Input pulses coming in faster than MICON 500C rated to handle.  Micro motion meter may be programmed for higher <i>ppu</i> than MICON 500C rating.	Ensure micro motion meter and MICON 500C flow rates are compatible.	1. Correct source of error. 2. Turn handle switch OFF, then ON.
<b>CO28</b>	DISPLAY DISCONNECT FAULT	LCD lost connection.	Check connections. If connections are valid, display may require replacement.	1. Correct source of error. 2. Turn handle switch OFF, then ON.
<b>CO29</b>	EEPROM CHECKSUM FAULT	EEPROM corrupted.	Reset pumphead by turning handle switch OFF, then ON.  If reset ineffective, reprogram the MICON, using the INFO-PAC.  If reset and reprogramming ineffective, internal processor may require replacing. Contact your service representative.	1. Correct source of error. 2. Turn handle switch OFF, then ON.
<b>CO30</b>	EXCESSIVE REVERSE COUNTS	Pulser connected backwards.	Reconnect pulser (see section 4.2 – American, pp 11-12; section 4.3 - European, pp 13-14)	1. Correct source of error. 2. Turn handle switch OFF, then ON.
<b>CO51</b>	EXCESS FLOW FAULT	Flow rate has exceeded INFO-PAC maximum setting OR hose ruptured.	Check for hose ruptures. If no leaks are occurring, it may be necessary to adjust INFO-PAC EXCESS FLOW setting (see section 8.6, page 36).	➤ Turn handle switch OFF, then ON— <b>OR</b> — ➤ activate MRST input and/or push button on main board
<b>CO76</b>	PRESSURE TRANSDUCER 1 OUT OF RANGE	Pressure transducer 1 input is less than or greater than 4 mA to 20 mA acceptable range.	Check transducer connections / performance.	Activate MRST input and/or push button on main board.
<b>CO77</b>	PRESSURE TRANSDUCER 2 OUT OF RANGE	Pressure transducer 2 input is less than or greater than 4 mA to 20 mA acceptable range.	Check transducer connections / performance.	Activate MRST input and/or push button on main board.
<b>CO78</b>	AMBIENT TEMPERATURE PROBE FAULT	Probe has short circuit or open circuit.	Check probe connections / replace probe.	Activate MRST input and/or push button on main board.
<b>CO79</b>	GAS TEMPERATURE TRANSDUCER OUT OF RANGE	Gas temperature transducer input is less than or greater than -50°C to +50°C acceptable range.	Check transducer connections / performance.	Activate MRST input and/or push button on main board.
<b>CO80</b>	PRESSURE TRANSDUCERS 1 AND 2 OUT OF TOLERANCE	Pressure transducers PXT1 and PTX2 (back-up) have exceeded a 3% difference in readings.	Check transducer connections / performance.	Activate MRST input and/or push button on main board.
<b>CO81</b>	AIR PURGE OR PRESSURE SWITCH KILL	Purging is not occurring, due to open circuit at switch. (This switch input may be used for applications other than air purge.)	Qualified personnel may check for open circuit and repair switch.	Activate MRST input and/or push button on main board.
<b>CO82</b>	EXCESS FILL FAULT	Flow rate has exceeded INFO-PAC maximum setting OR hose ruptured.	Check for hose ruptures. If no leaks are occurring, it may be necessary to adjust INFO-PAC EXCESS FILL setting (see section 8.6, page 36).	Activate MRST input and/or push button on main board.

CODE	SUMMARY OF FAULT CLEARING ACTIONS
<b>CO26 – 30</b>	<ol style="list-style-type: none"> <li>1. Correct source of error.</li> <li>2. Turn handle switch OFF, then ON with authorization.</li> </ol>
<b>CO51</b>	Turn handle switch OFF, then ON—OR—activate MRST (manual reset switch) input and/or push button on main board.
<b>CO76 – 82</b>	Activate MRST (manual reset switch) input and/or push button on main board.







## **Kraus Group Inc.**

---

25 Paquin Road, Winnipeg, Manitoba, Canada, R2J 3V9

Telephone: 1 204 988 1234 Facsimile: 1 204 654 2881

Printed in Canada