

FRONT

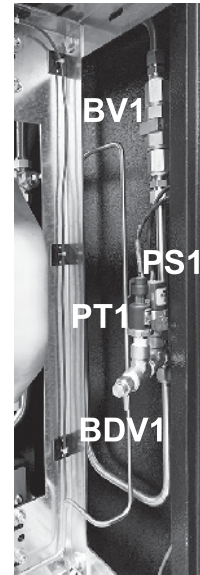

FRONT RIGHT

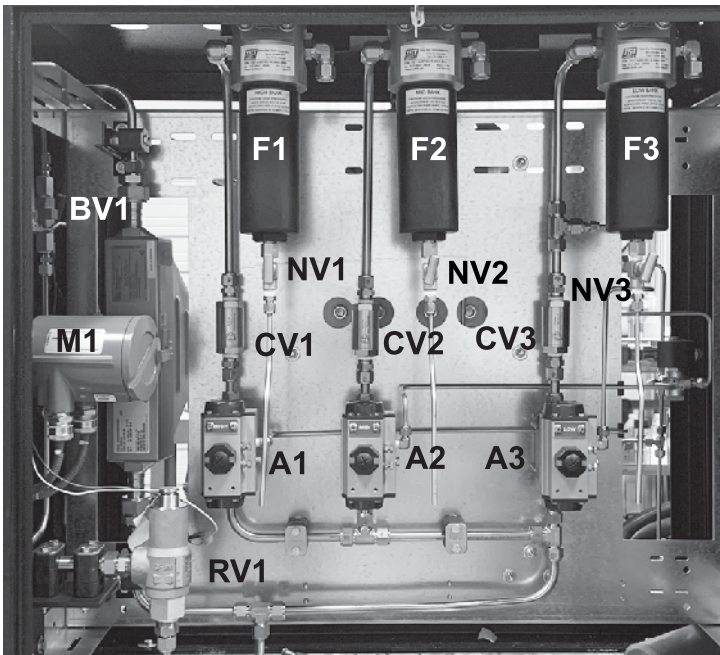

BACK

- A1-A3..... BI-TORQ ACTUATOR PN52SR AND OASIS BALL VALVE, BV704
- BV1..... OASIS BALL VALVE, 1/2" 700 SERIES
- BDV1..... PARKER BLEED VALVE, 4V-V4LR-SS-ST
- CIB..... TGT CUSTOMER INTERFACE BOARD (INSIDE BOX)
- CV1-3..... OASIS CHECK VALVE, 81-C8L-1-SS
- CV4..... OASIS CHECK VALVE, 1/4", CV102-3NBS0
- PS1..... PRESSURE SWITCH , NASON CD-1C-4500R/WL293
- PT1..... ASHCROFT PRESSURE TRANSMITTER, G27M02RMG25000#G

- R1..... REGULATOR, BELGAS P39
- RV1..... RELIEF VALVE, MERCER, 14-22B7112JX1
- RV2..... RELIEF VALVE, 1/4", KINGSTON, KSV-10-2
- M1..... METER, MICRO MOTION CNG50 MM-290NCAAEZZZ - SENSOR MM2700 / 13ABA3ZZZ - TRANSMITTER
- F1,2,3..... FILTER TGT-A-8519C-N.3MA-BS6
- NV1,2,3.. NEEDLE VALVE, NOSHOK T50
- PG1..... PRESSURE GAUGE 5000 PSI, WIKA 2.5" 427123
- S1-3..... ASCO RED HAT SOLENOID VALVE

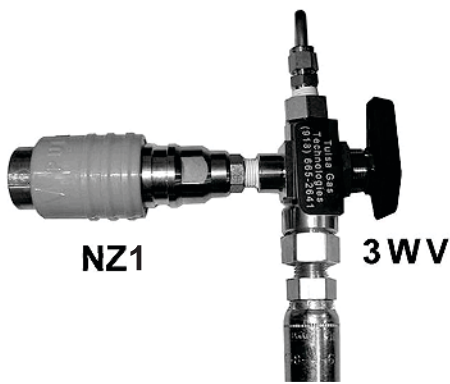

NZ1

3WV



PSIG



BB

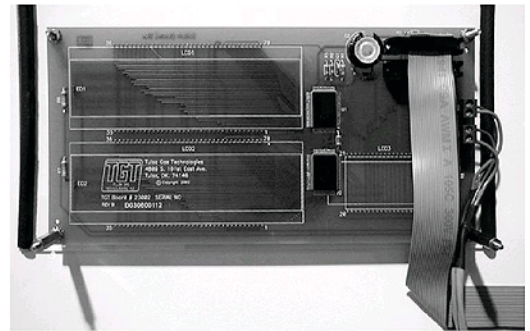

DB

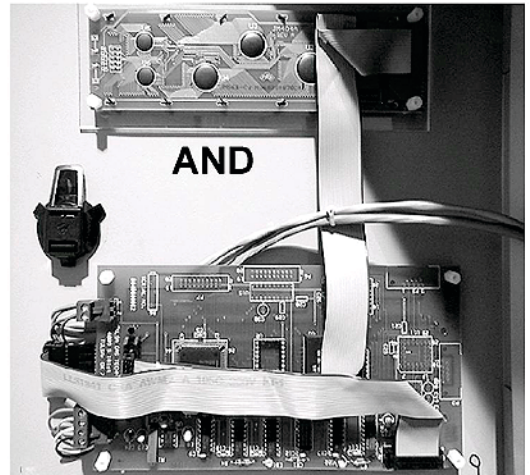

AND

MMI

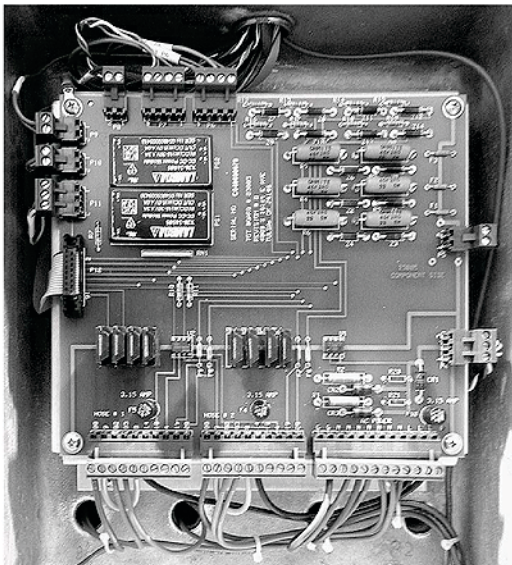

CIB

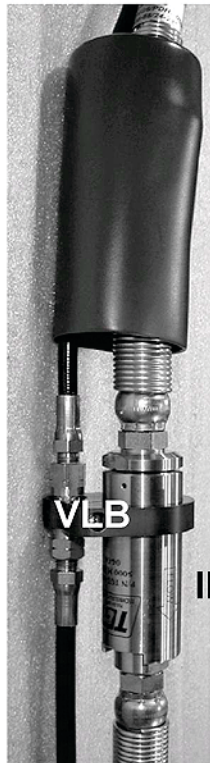

VLB

ILB

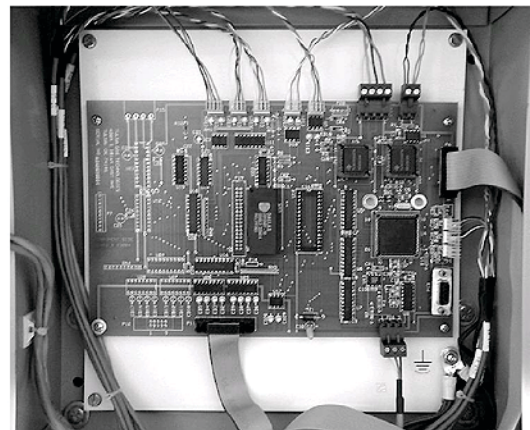

MB

- AND....ALPHA-NUMERIC DISPLAY,
4 LINE X 40 CHAR., DCI404AF3BW6
- BB....TGT BREAKAWAY BASE
- CIB...CUSTOMER INTERFACE BOARD,
TGT 23005
- DB.....DISPLAY BOARD, 23002
- ILB...TGT-6ILB IN-LINE BREAKAWAY
- MMI...MAN-MACHINE INTERFACE BOARD,
TGT 23007
- MB....MAIN BOARD, TGT 23004
- NZ1,2..STAUBLI P36 NOZZLE
- PSIG...WIKA 0-6000 PRESSURE GAUGE, SS,
8992945-0012
- VLB...TGT VENT-LINE BREAKAWAY
- 3WV....3 WAY VALVE, PARKER 4F-HB4XPKR-SSP